

T5

T1 1r  
Sper





1mm  
errholz



T6

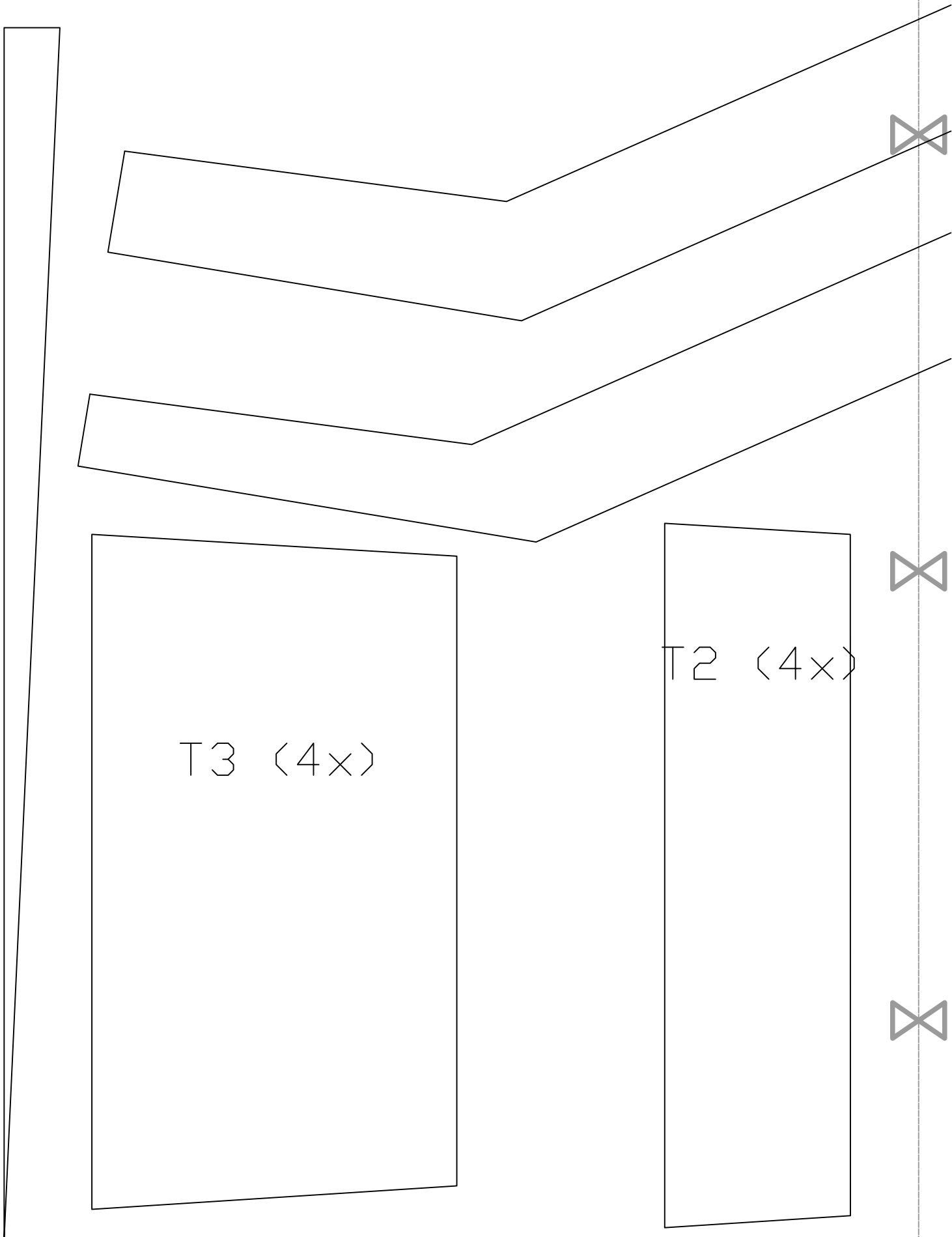

G1 (4x)

1mm Sperrholz

G2 (2x)

6mm Depron

A1 (12x)

A3 (6x)

A2 (2x)

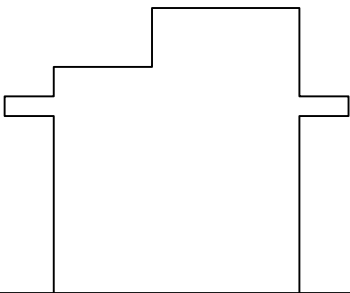

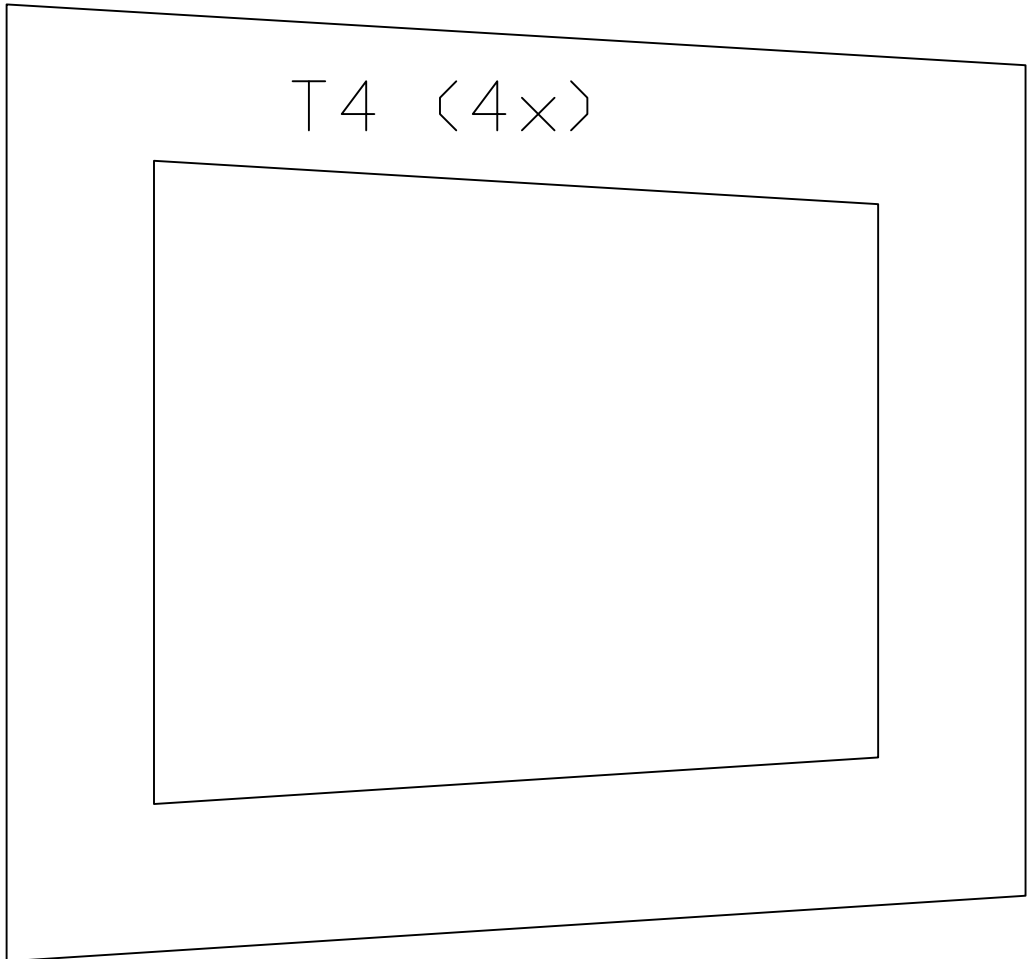
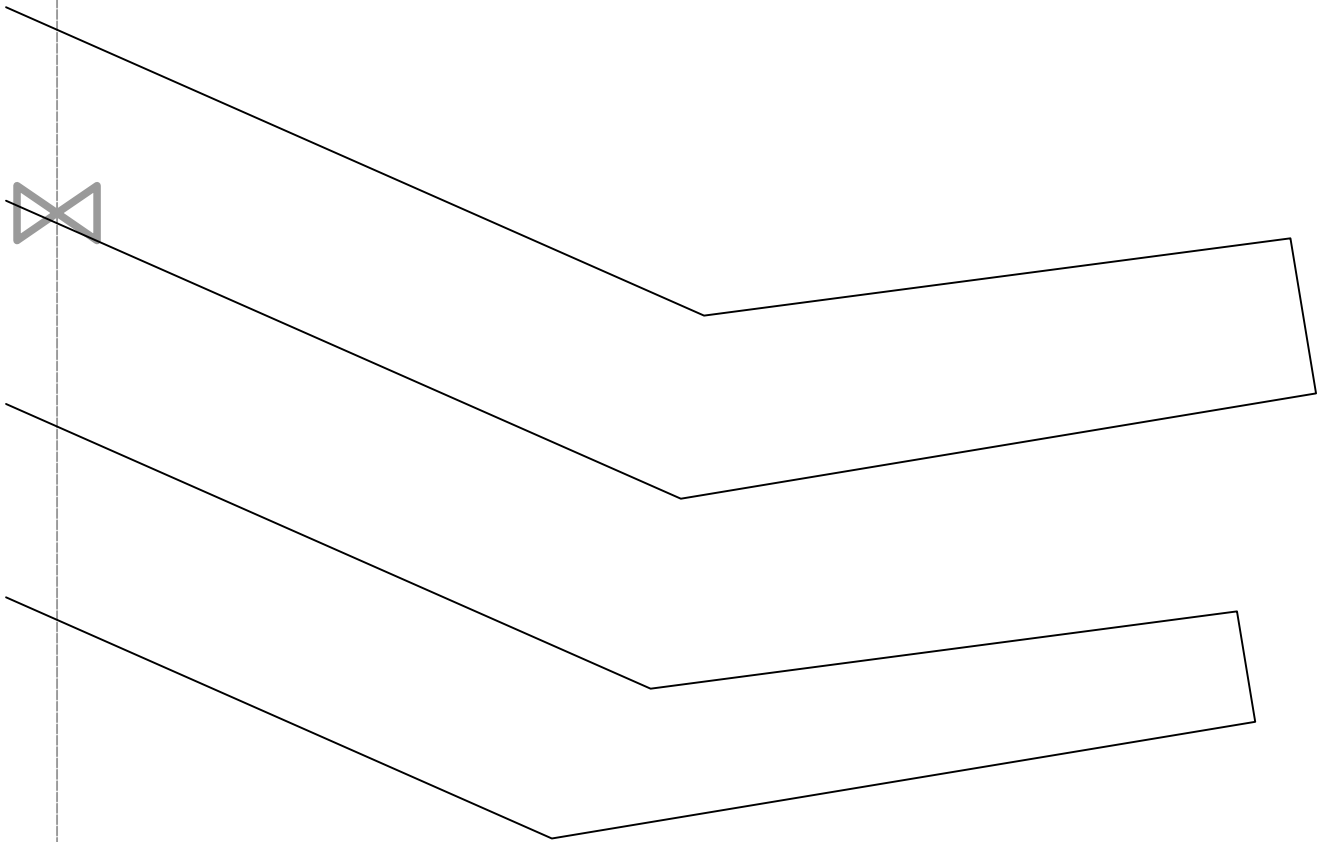

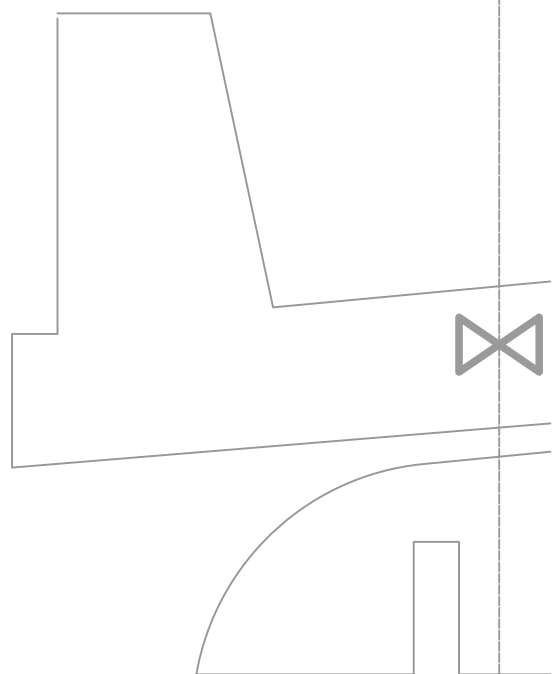
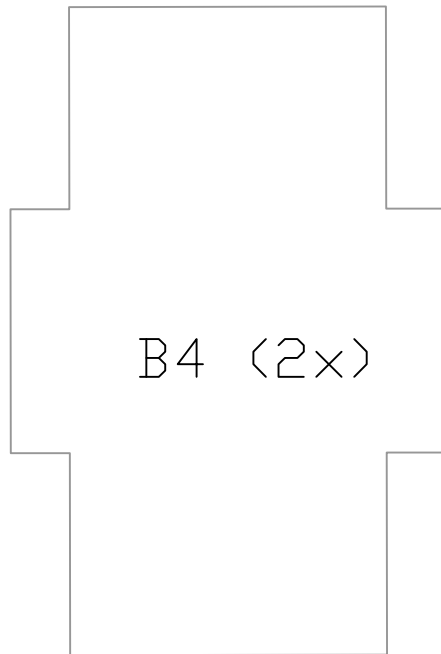
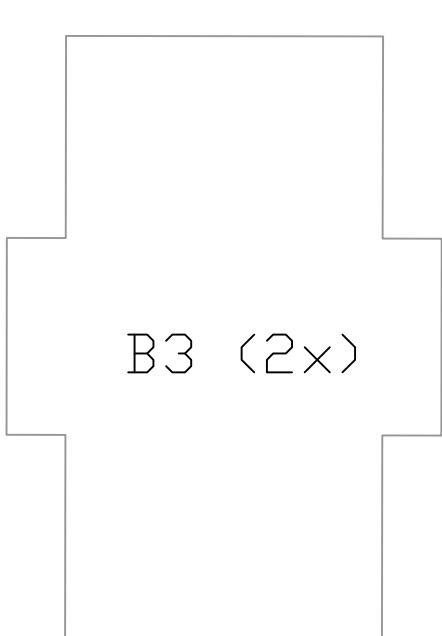
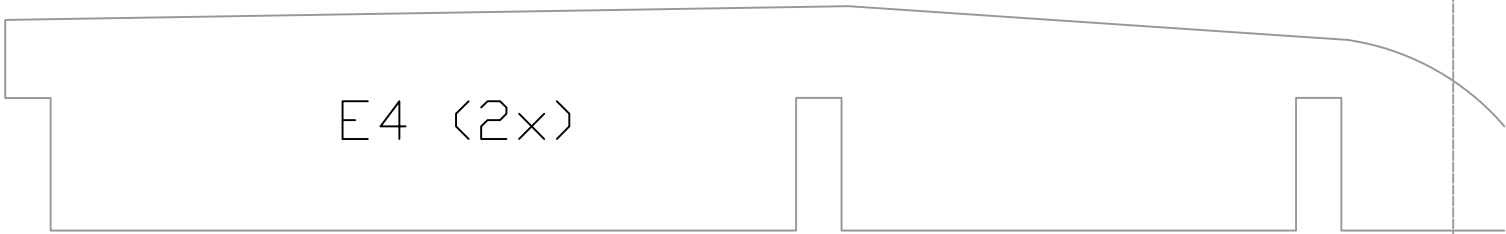
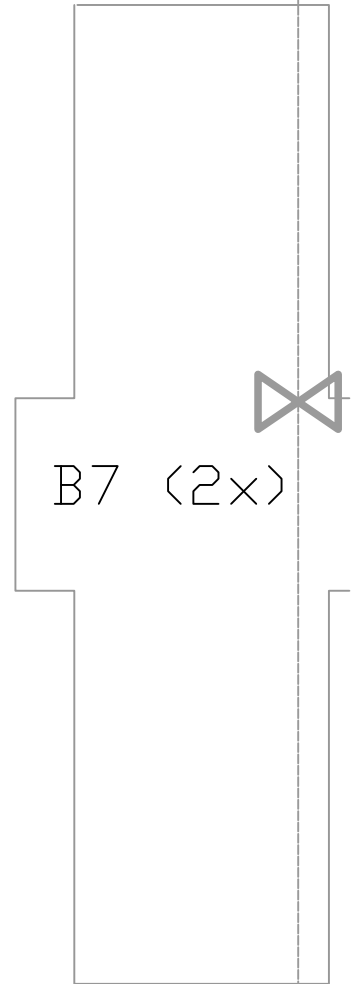

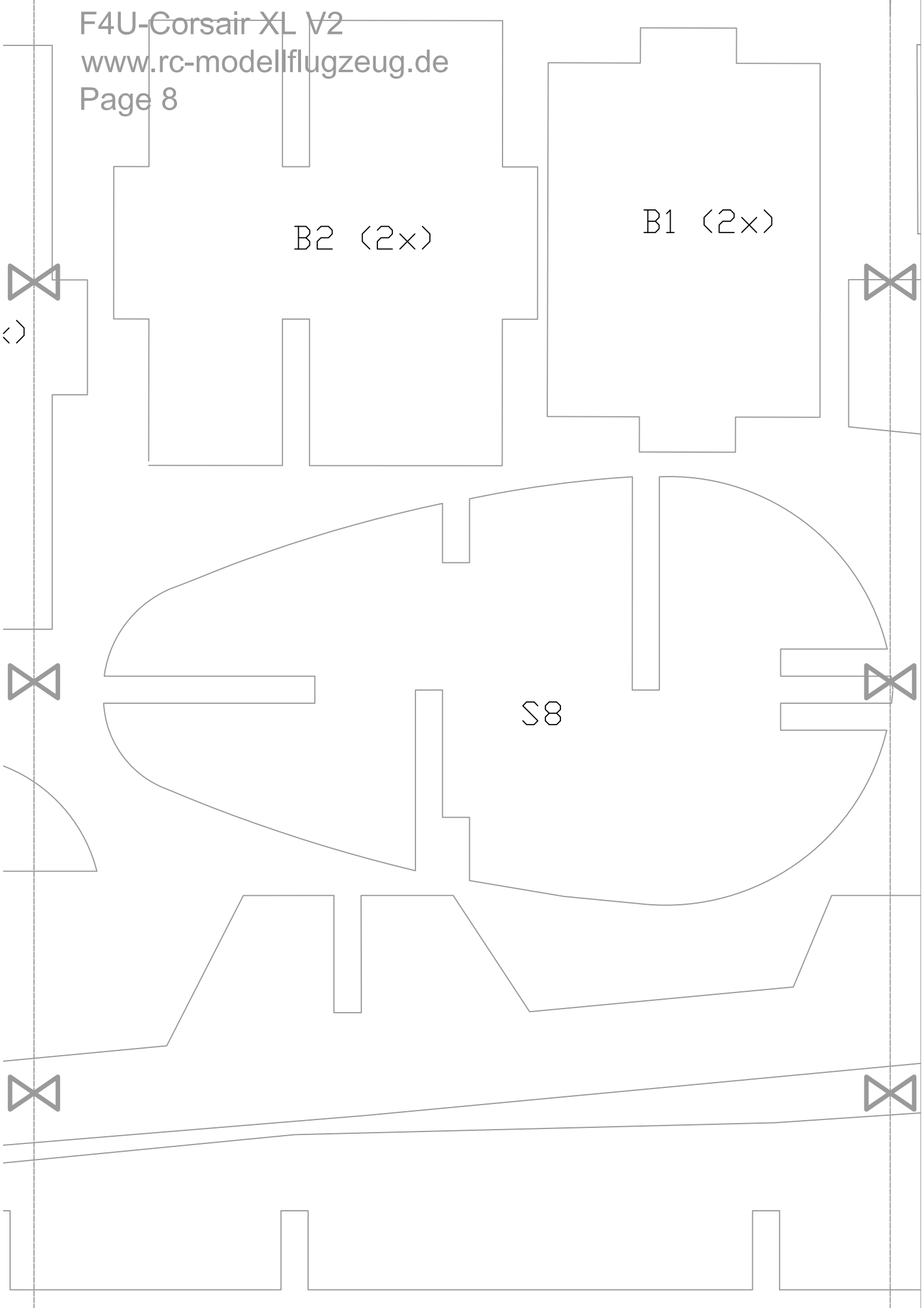

B2 (2x)

B1 (2x)

S8



C



B5 (2x)

B6 (2x)

R1 (2x)

E5 (2x)



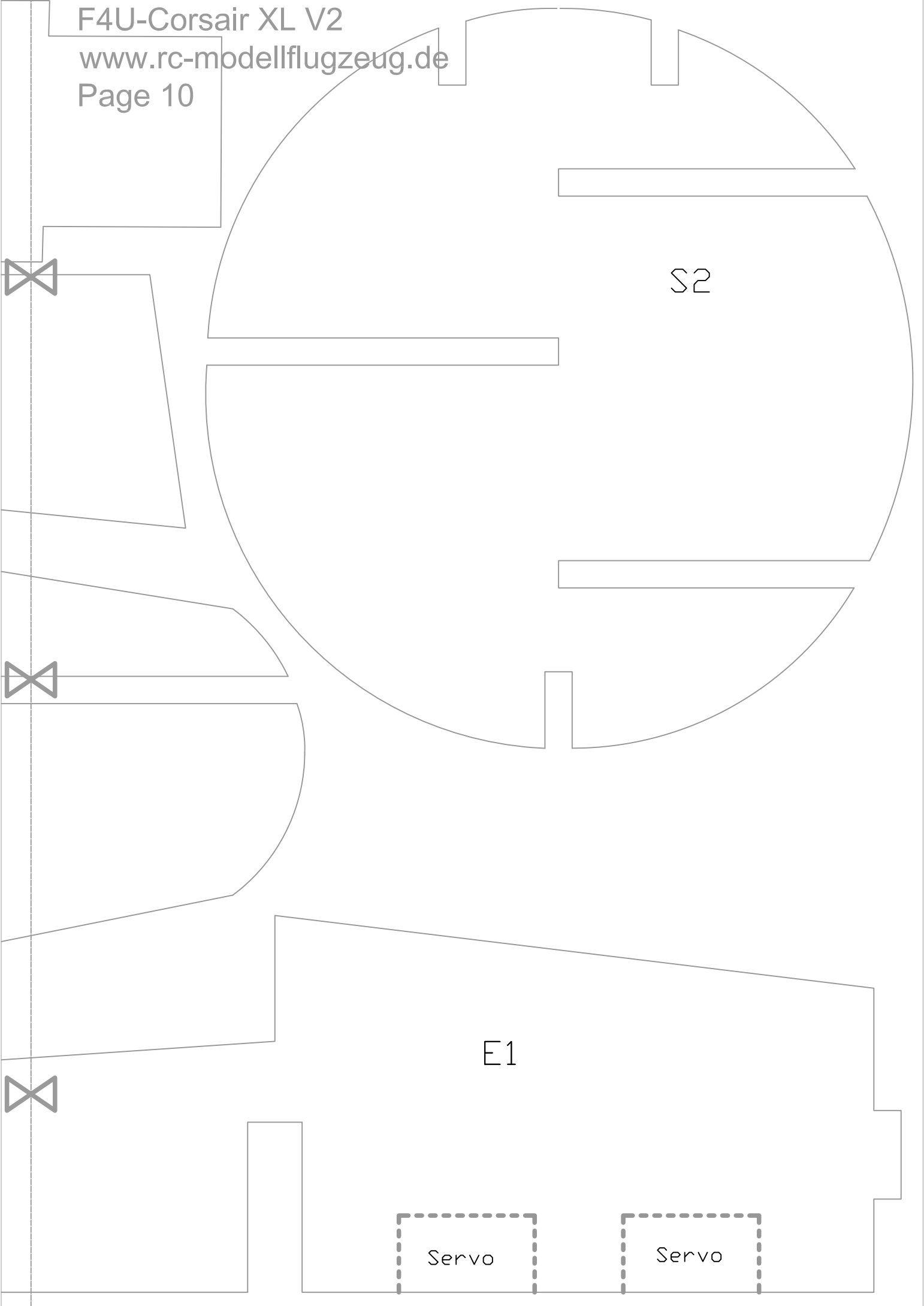

S2

E1

Servo

Servo

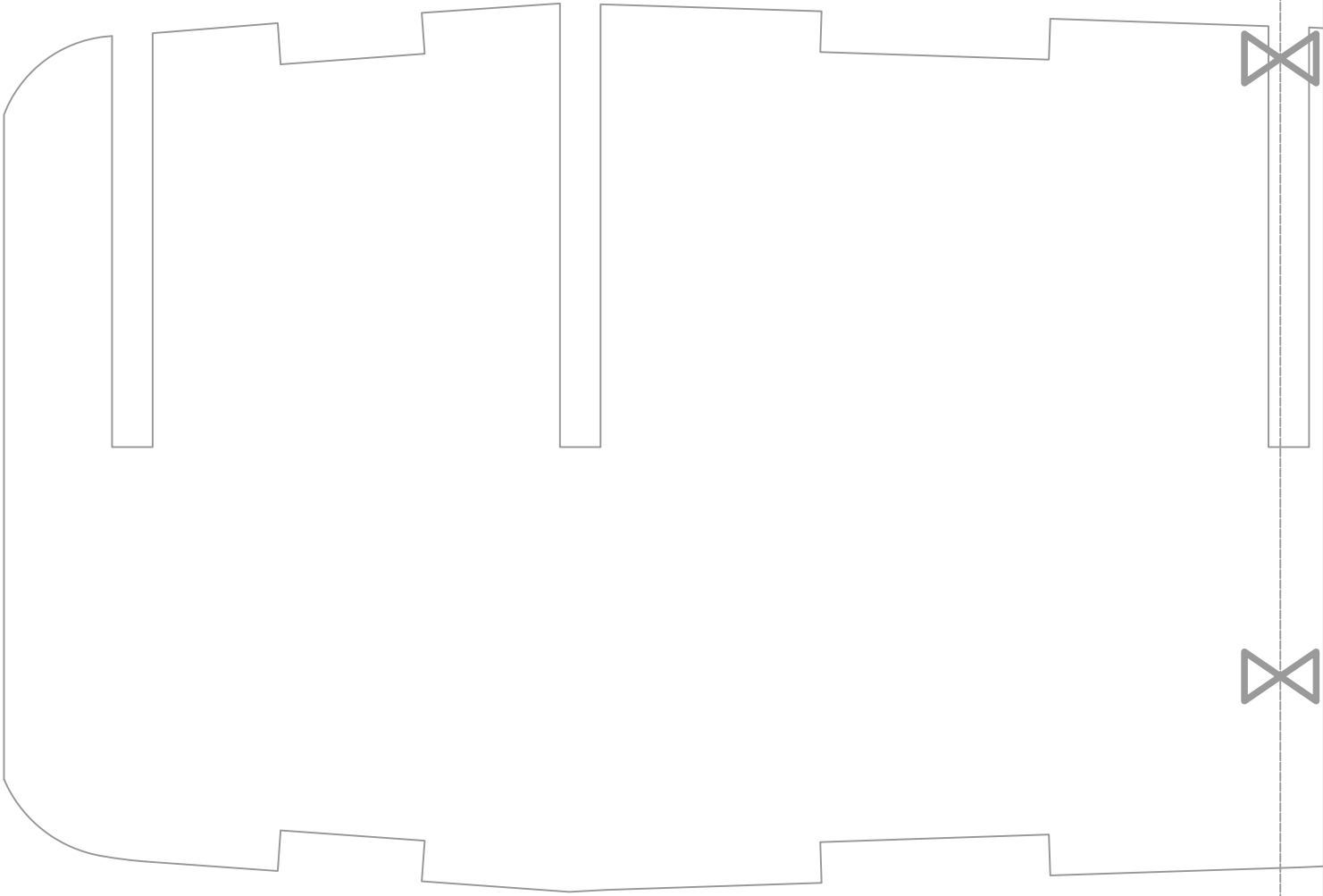
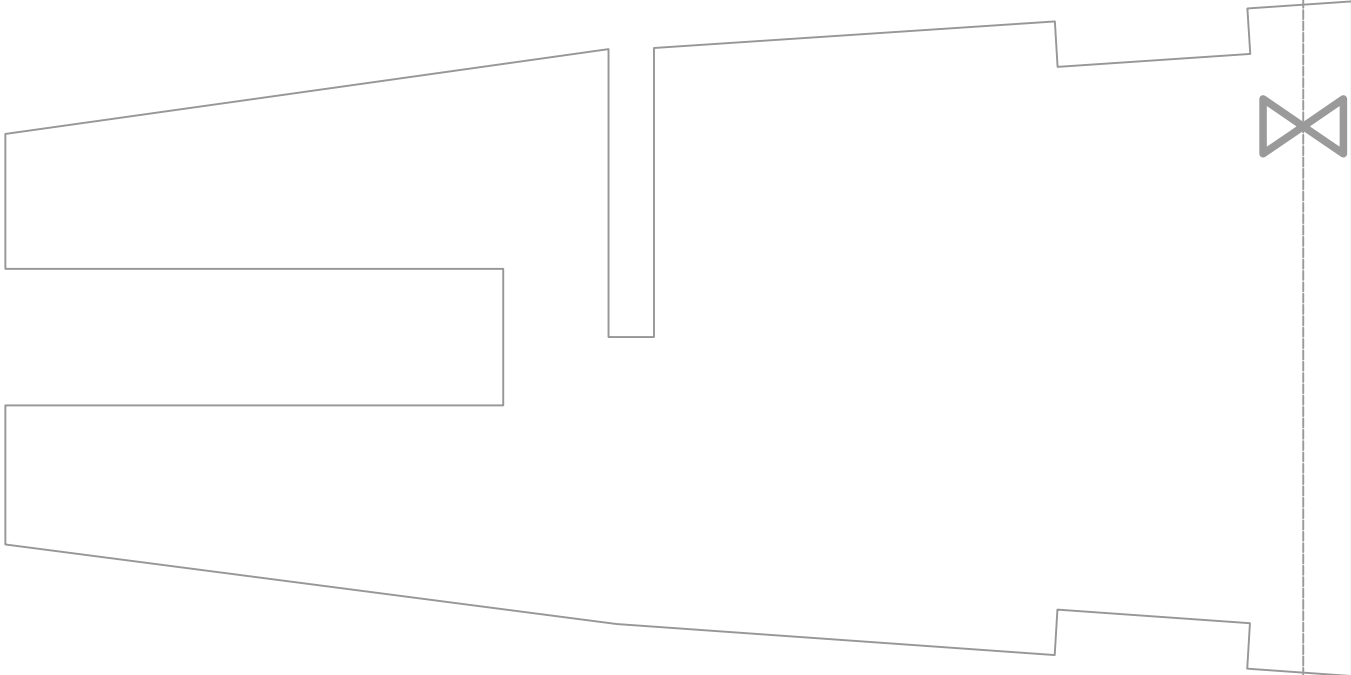

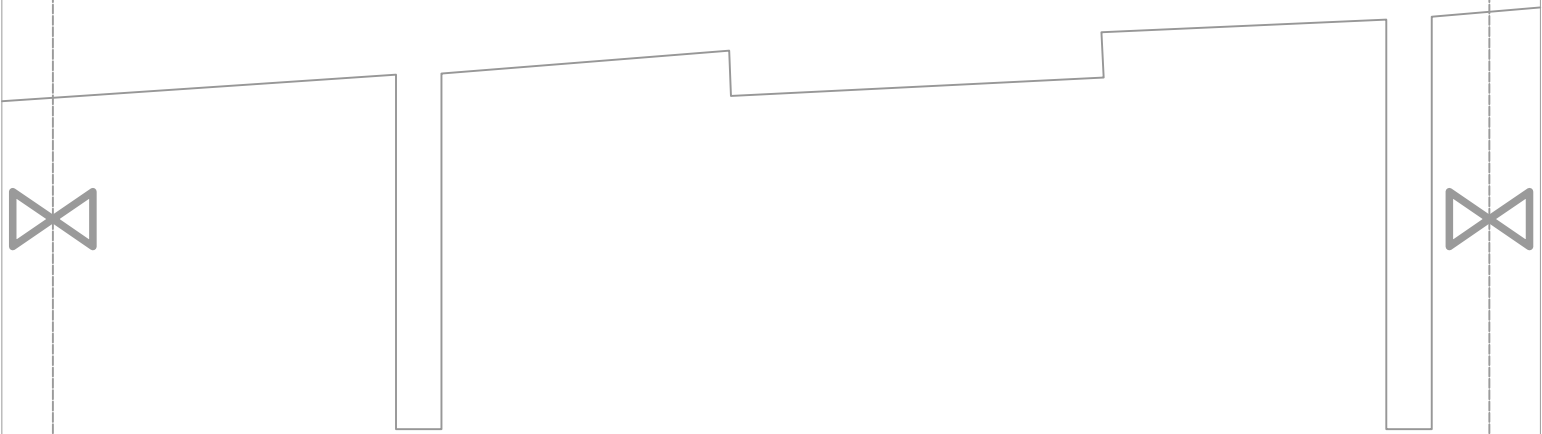

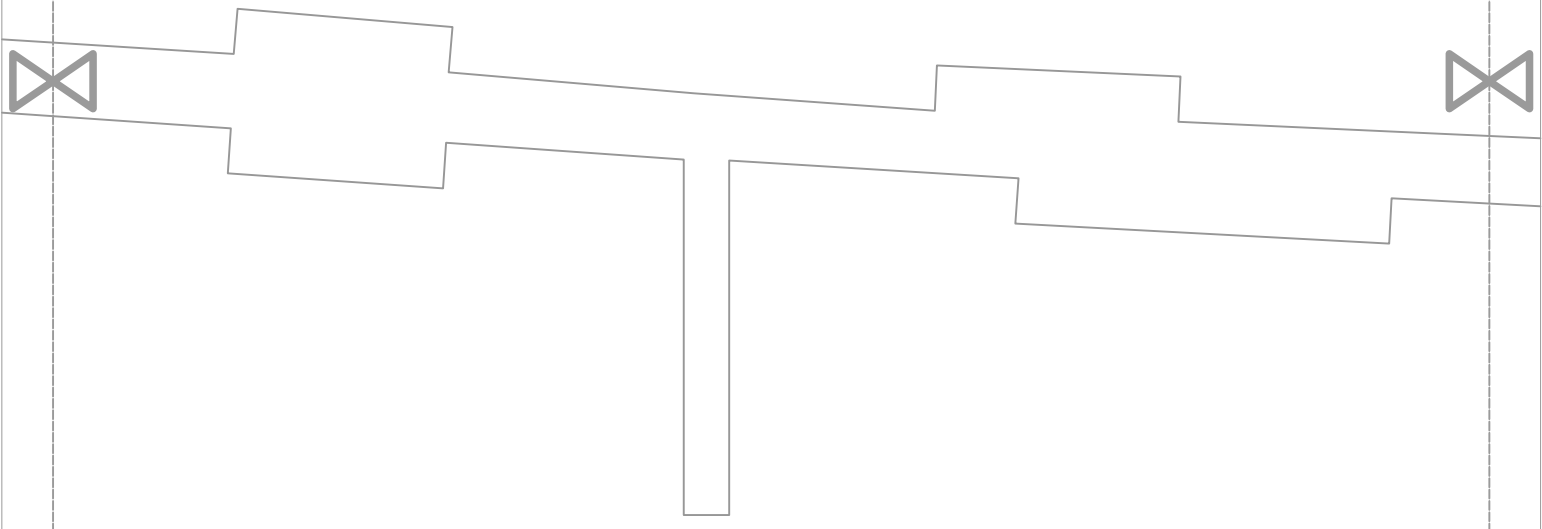
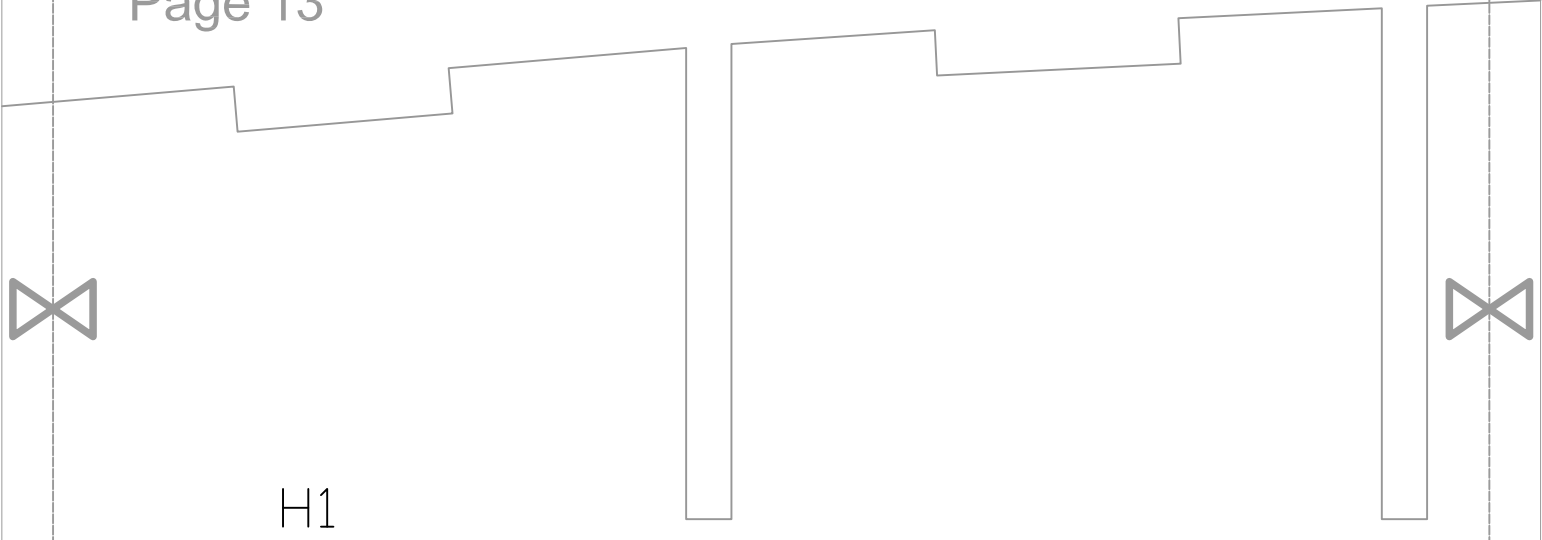

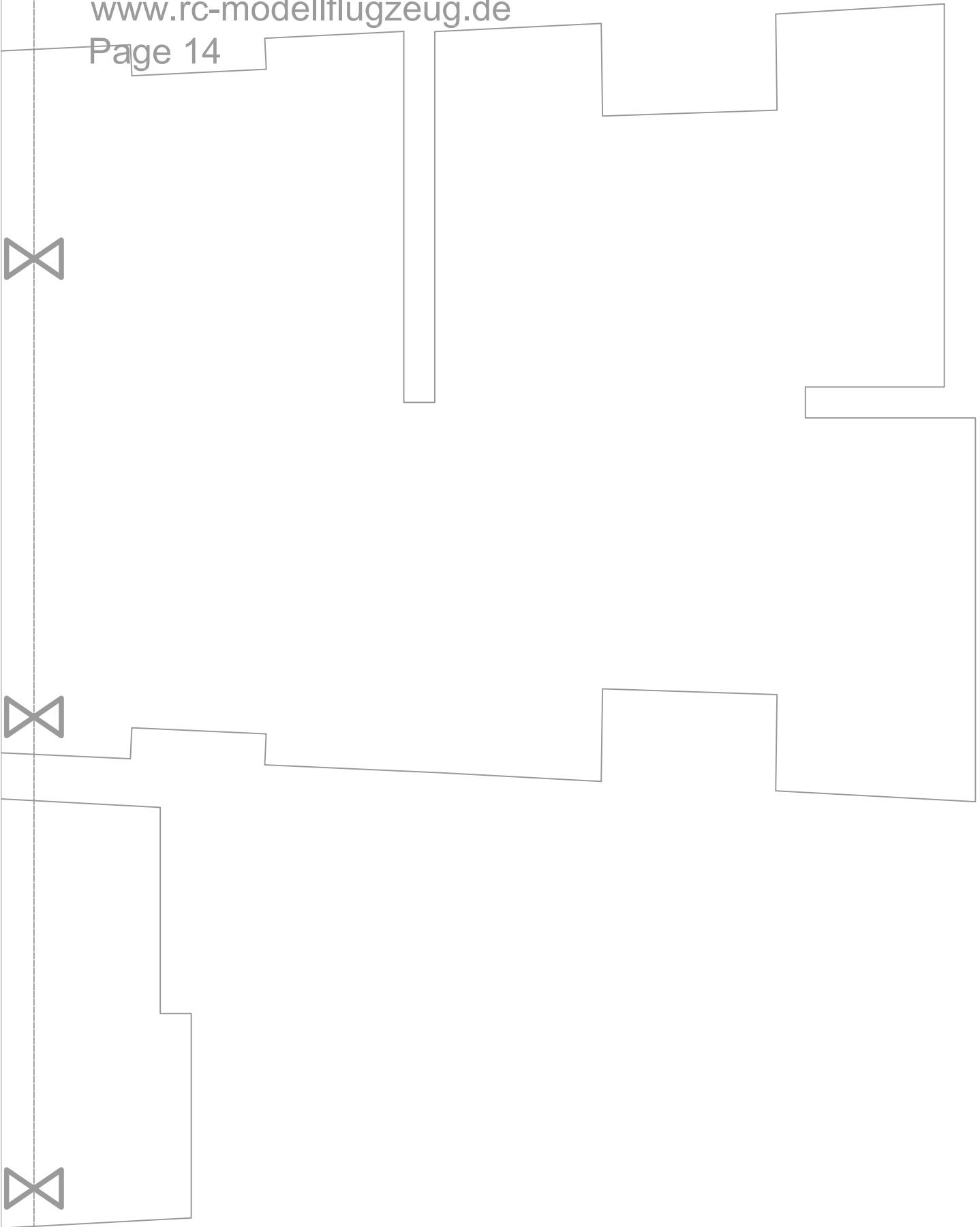

S3



R2

S6



Add Page 15



Add Page 17



L1





E2

S10

S7

Add Page 16

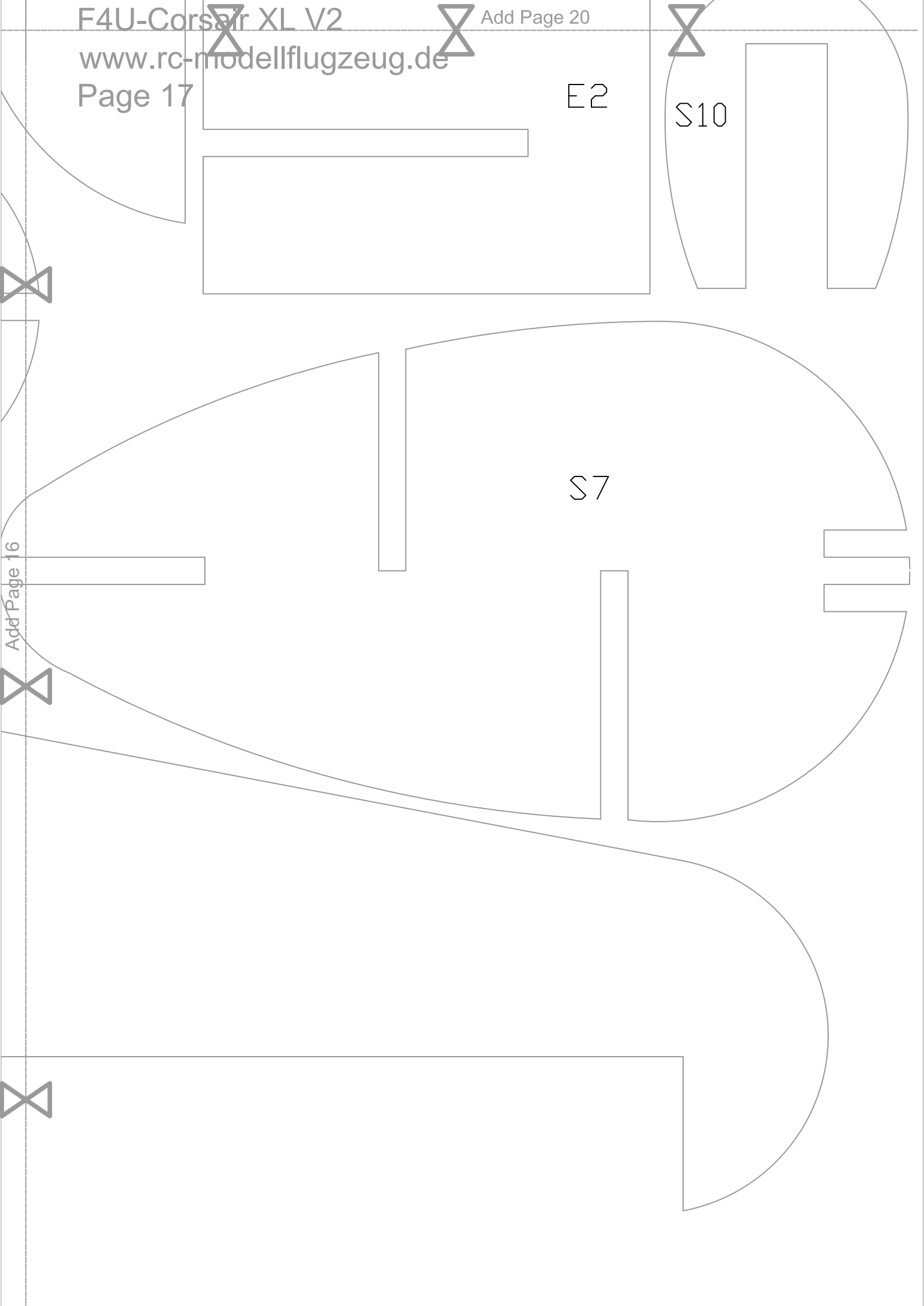

H3

E3

S5



Add Page 19

Add Page 15

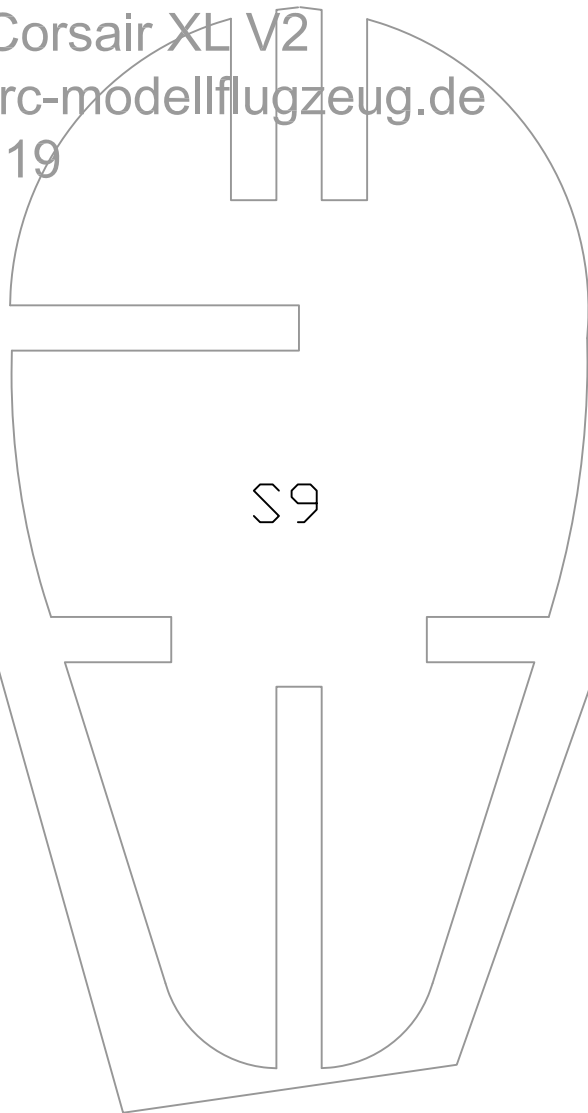

E4



Add Page 18

Add Page 20

Add Page 16

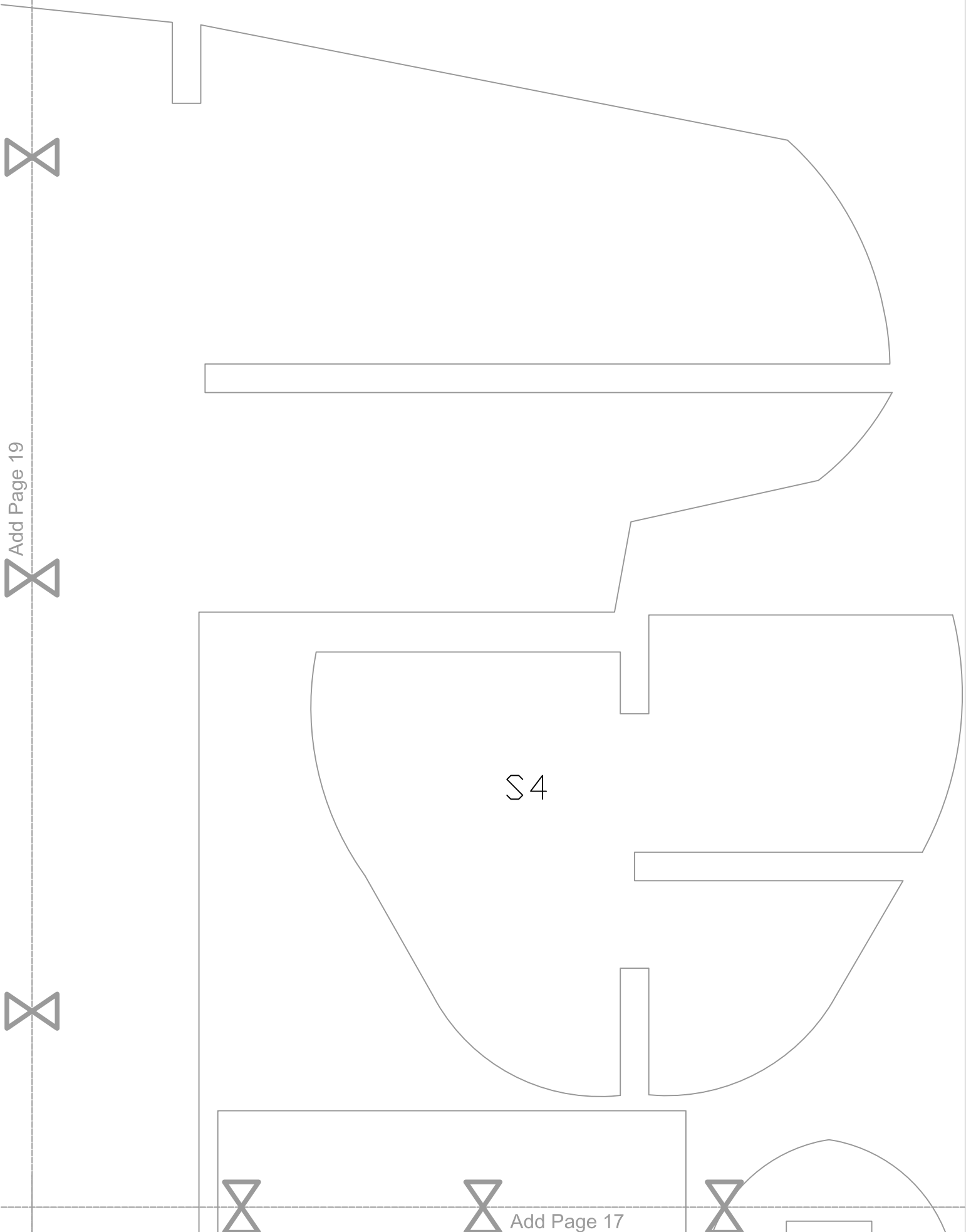

Add Page 19

S4

Add Page 17

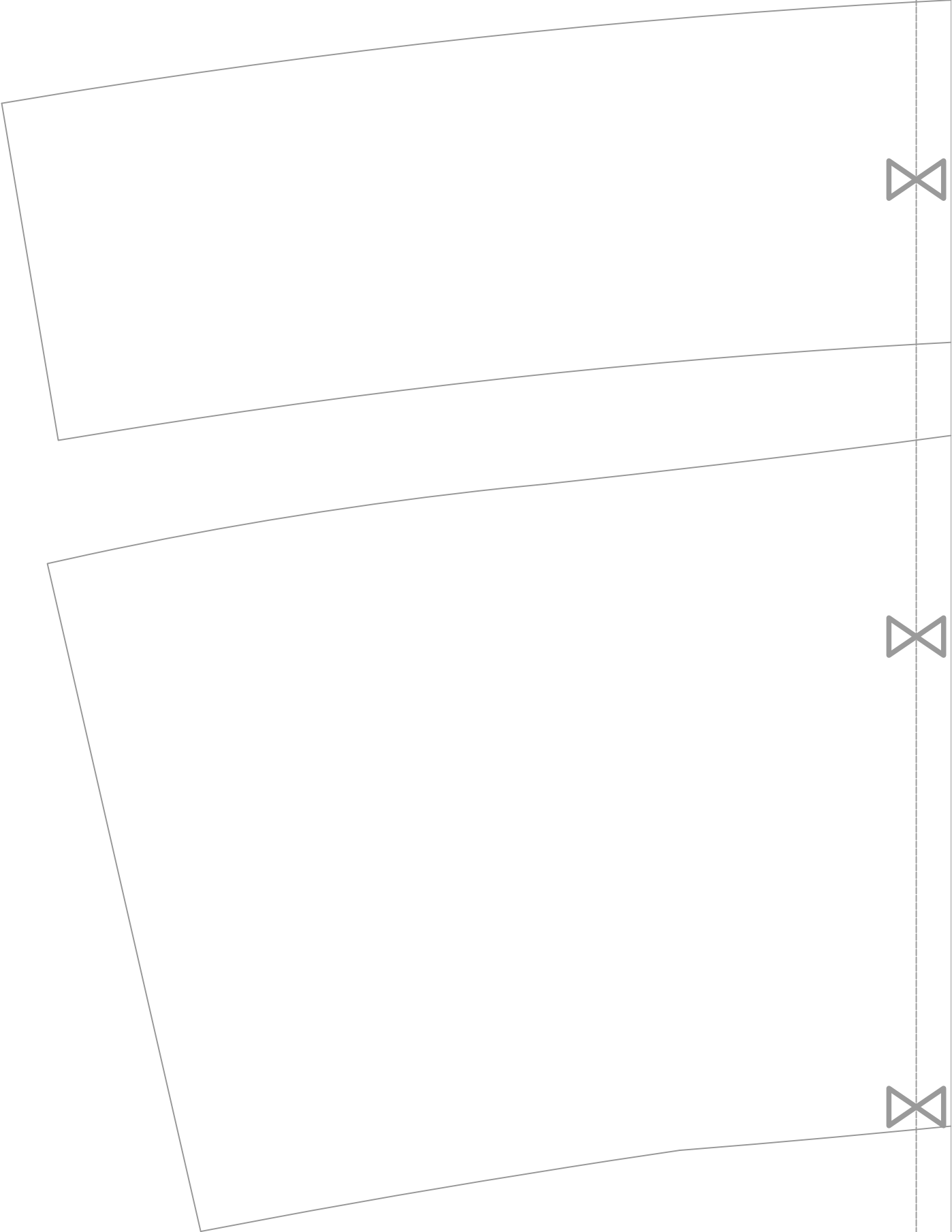



M1 (3mm Depron)



M4 (3mm Depron)



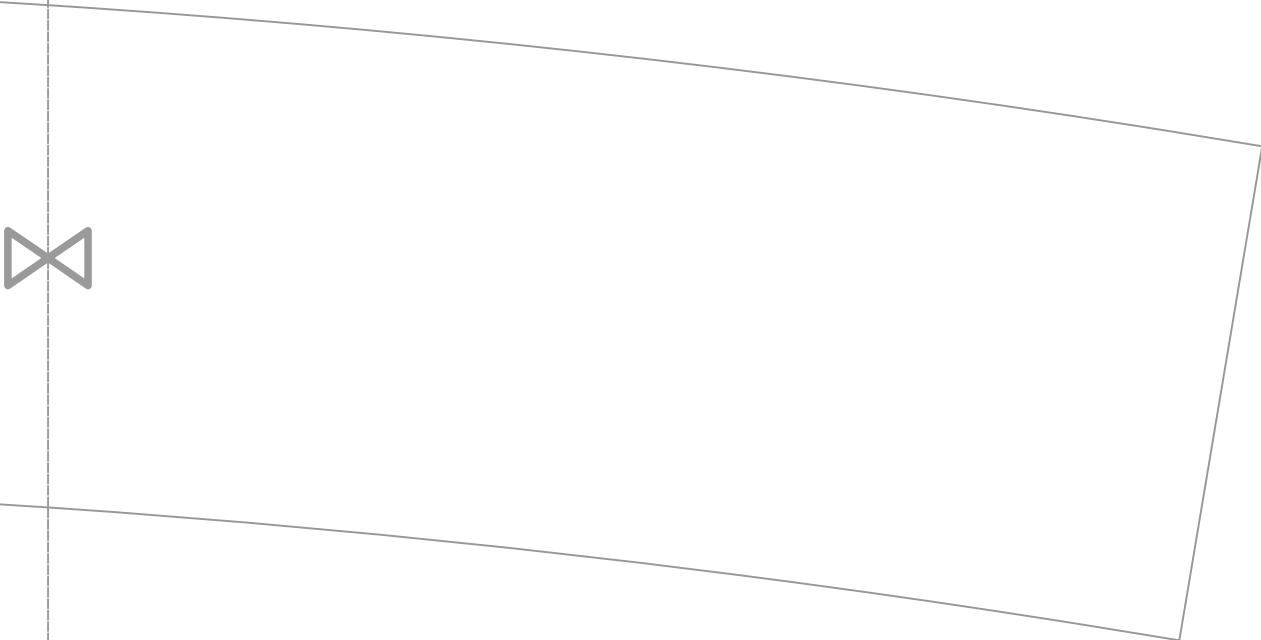



M3 (3mm Depron)



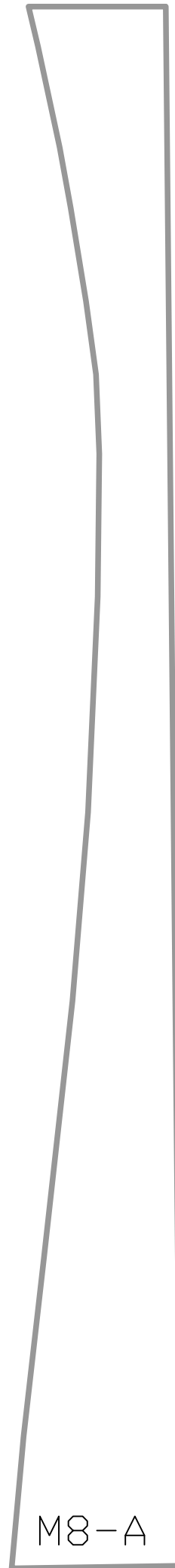





M7 (3mm Depron)



[W1

[W1



M2 (3mm Depron)



M9 (2x) (3





(3mm Depron)



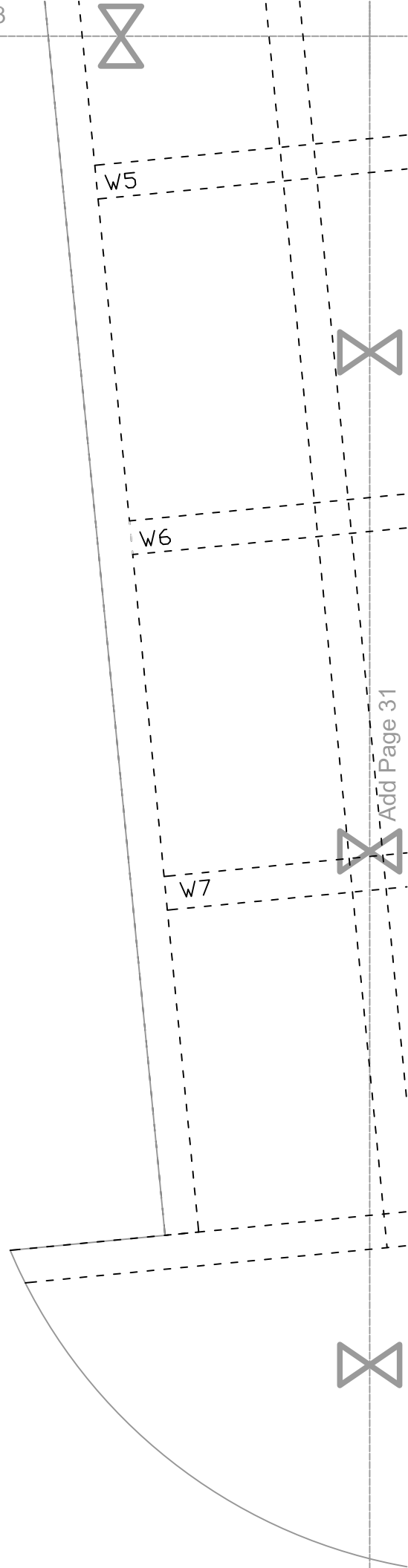
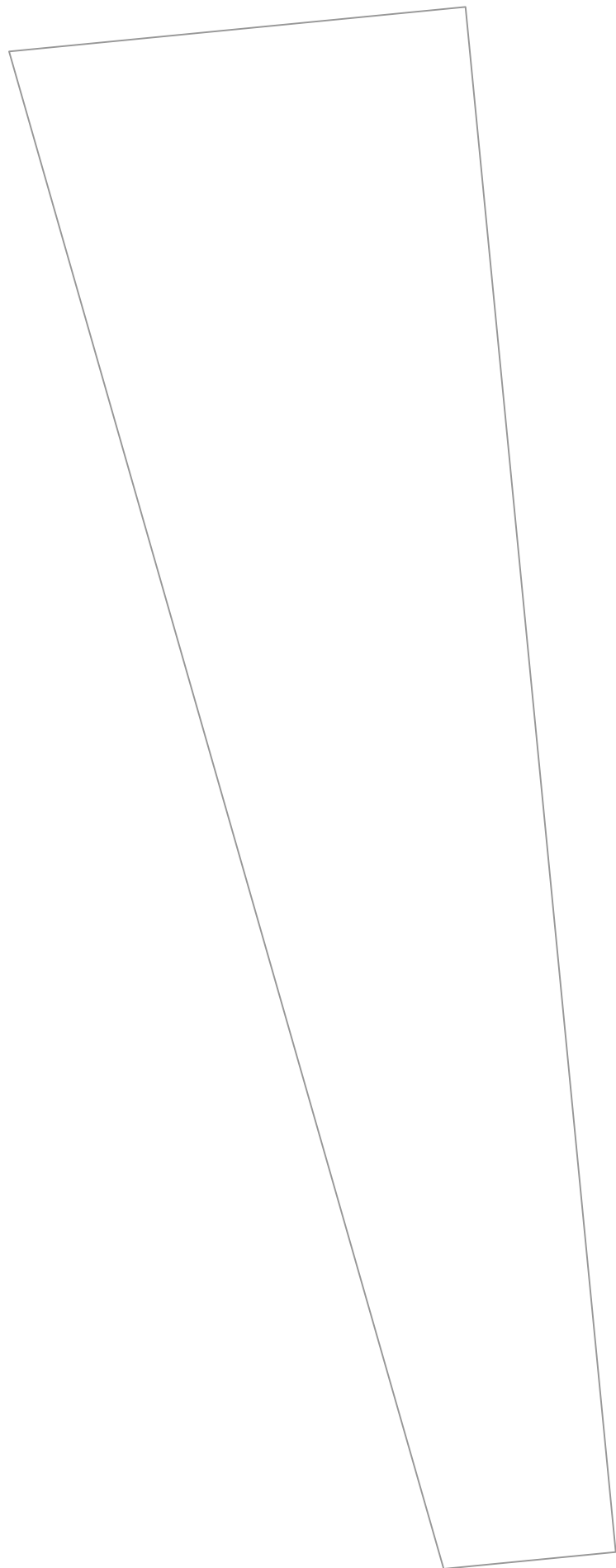

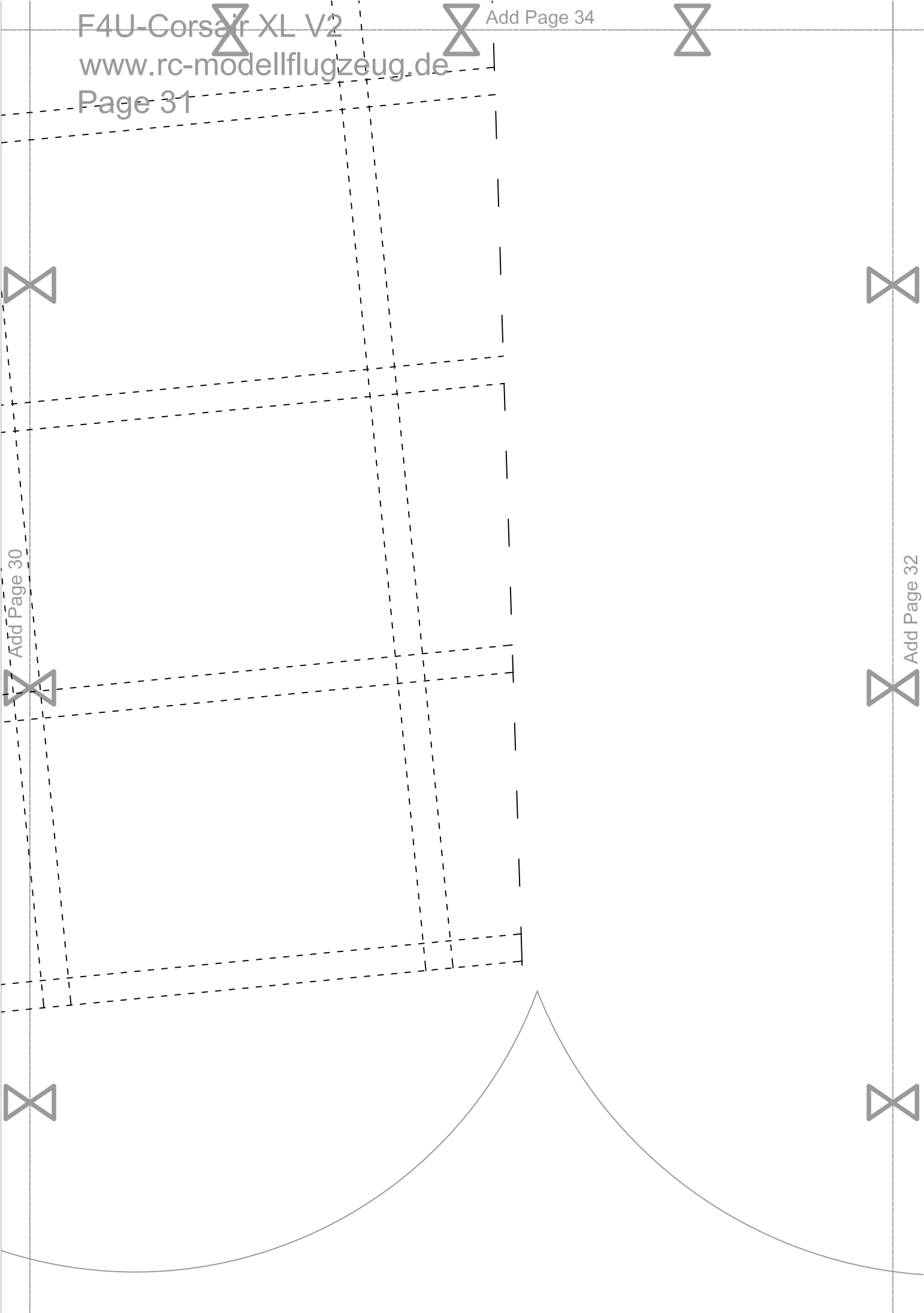

Add Page 30

Add Page 32



Add Page 31

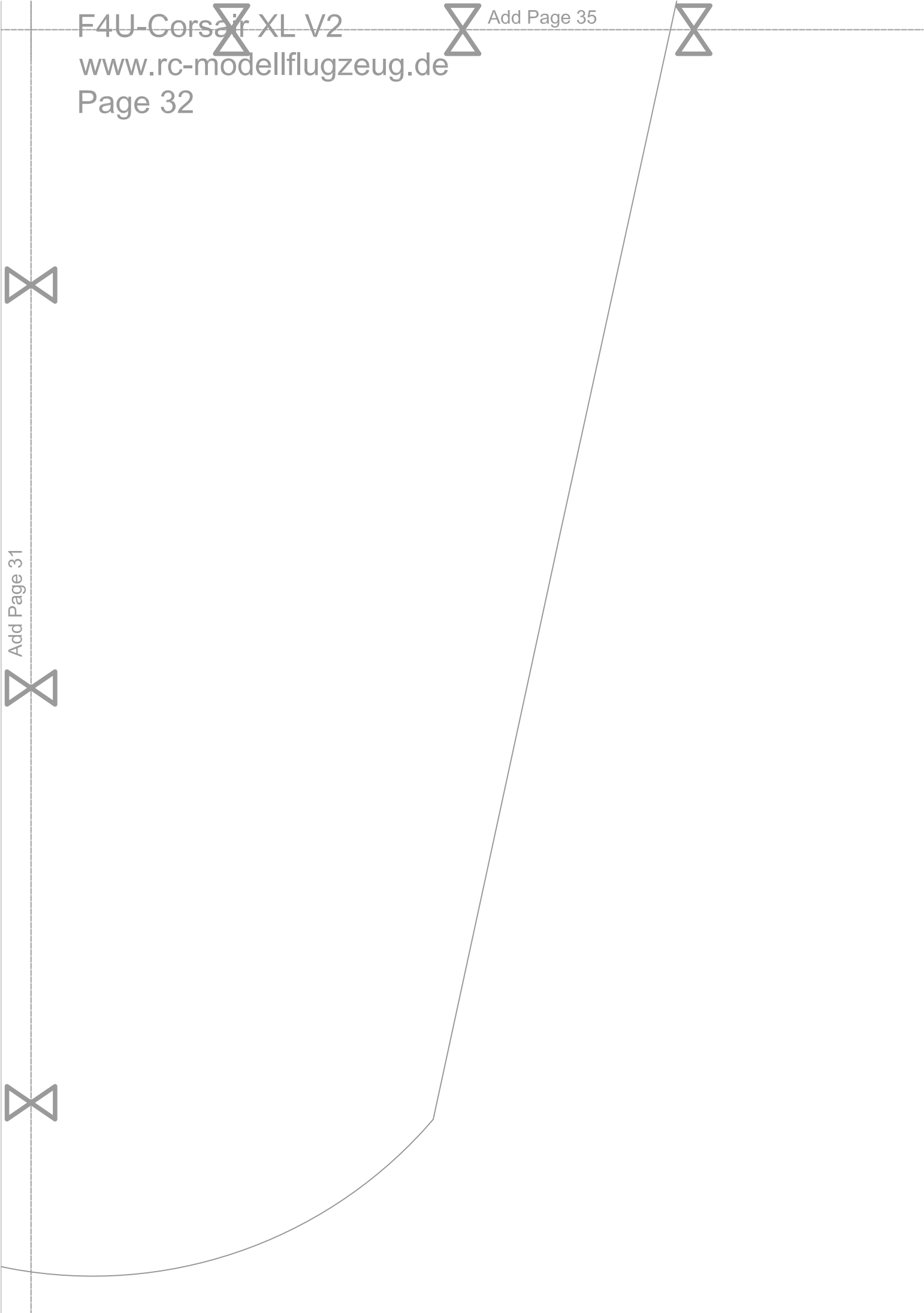



w1

w2

w3

w4

Unterseite



Add Page 34

Add Page 30



Add Page 33



Add Page 35



M6 (2x) (3mm D



Add Page 31



Depron)



Add Page 32



Add Page 34

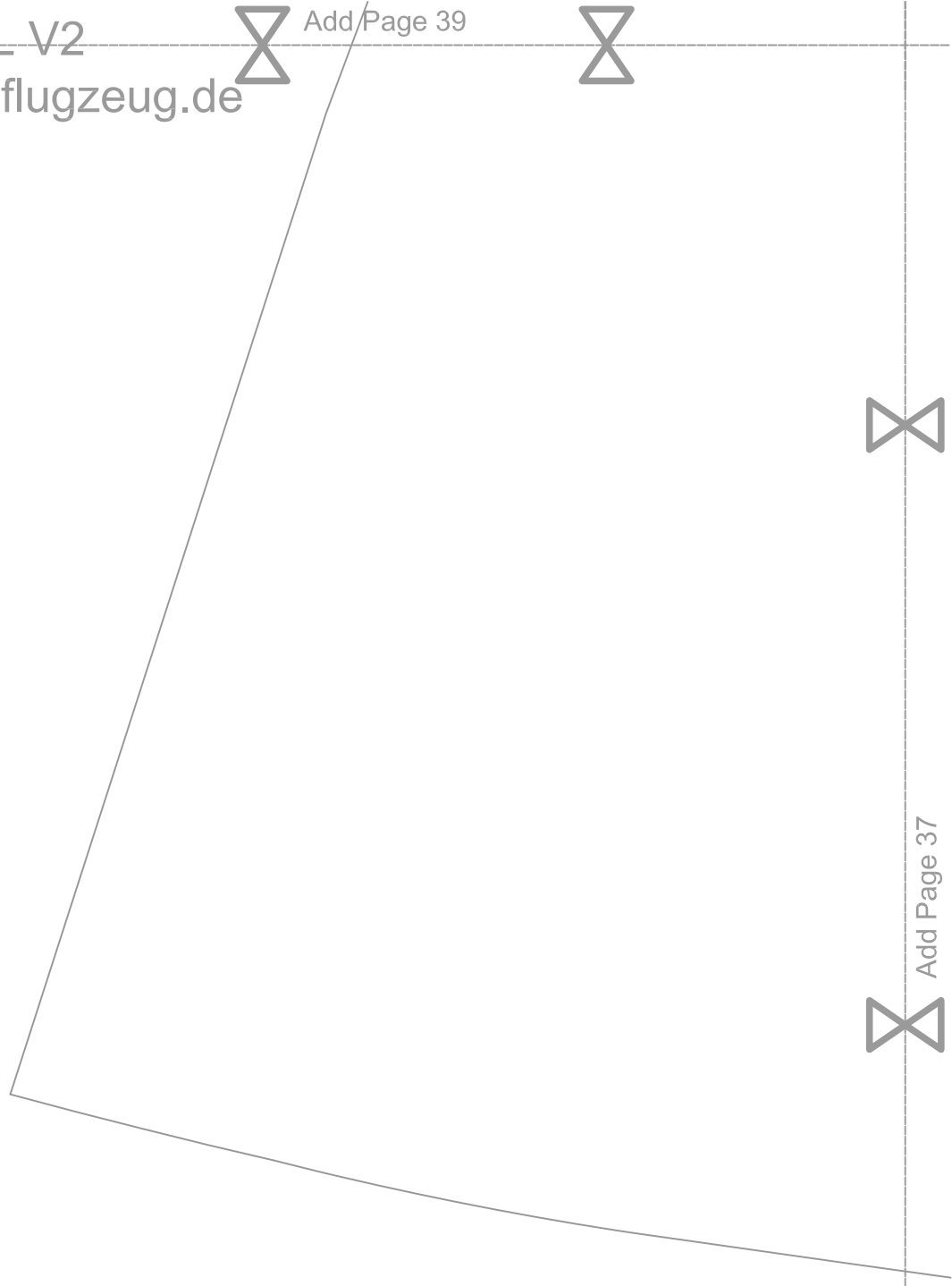

M5 (3mm Depron)



Add Page 37



Add Page 36



Add Page 40





Add Page 39



Add Page 41



Add Page 37







Add Page 40

Add Page 38