

T1 1mm
Sperrholz

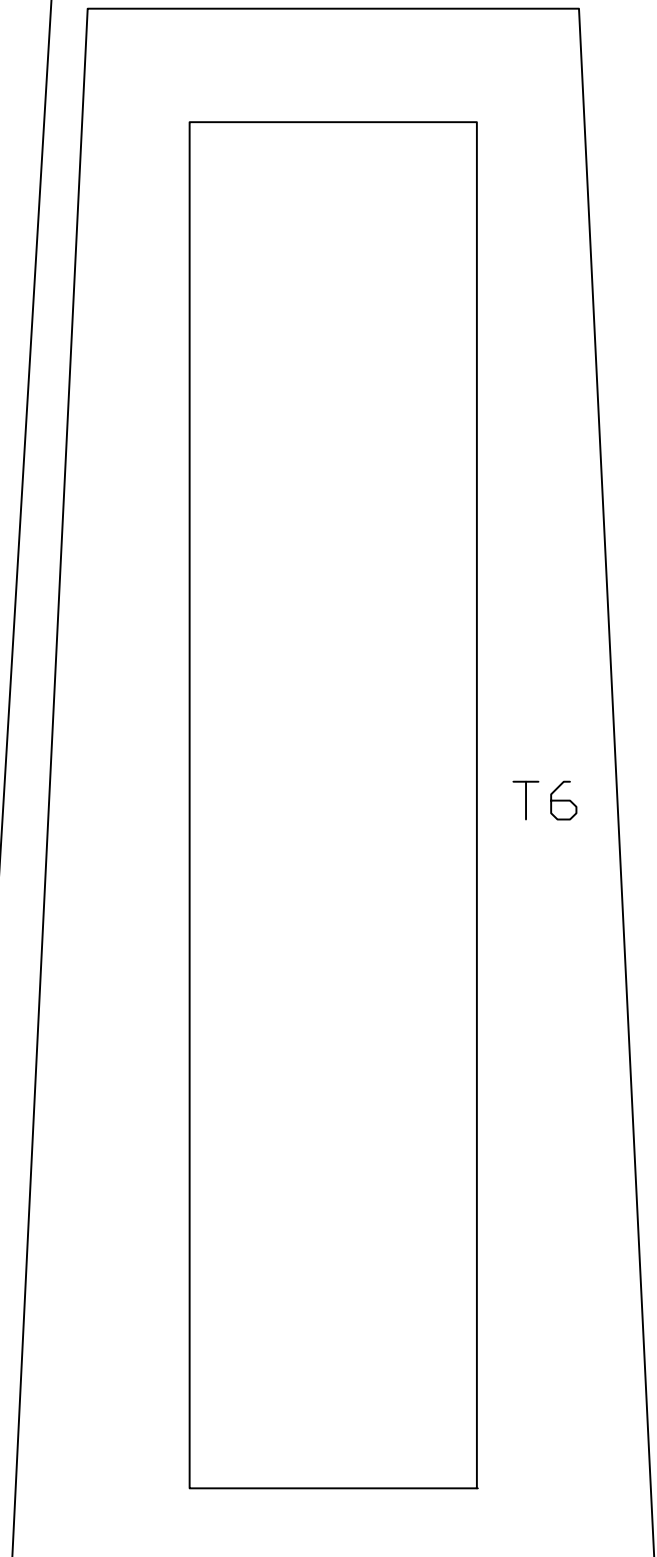
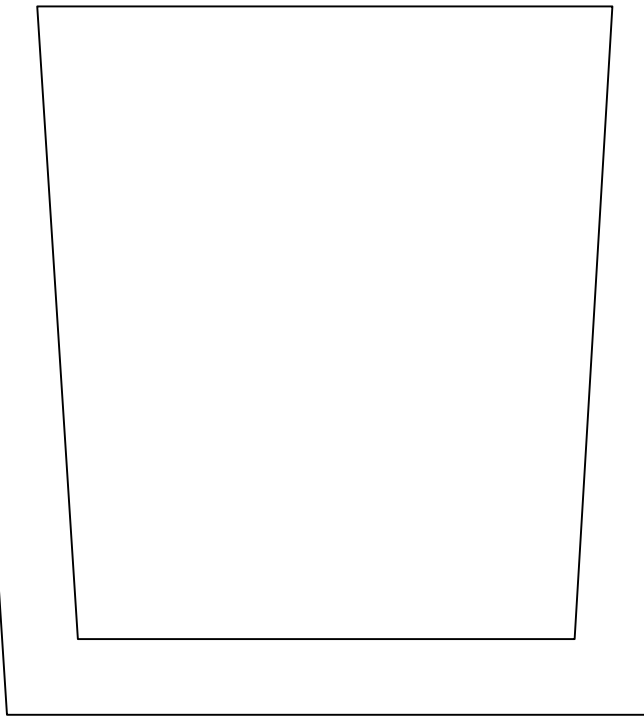

T6

A1 (12x)

A3 (6x)

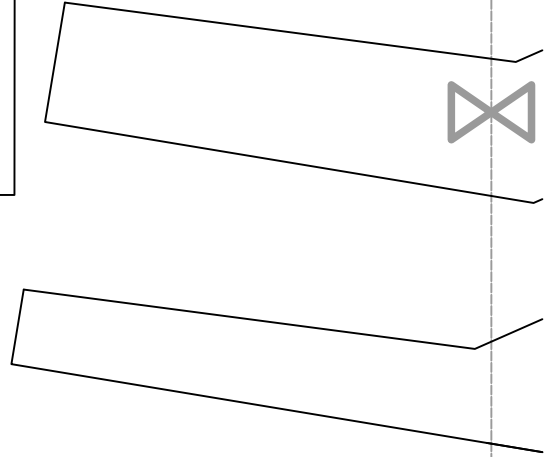
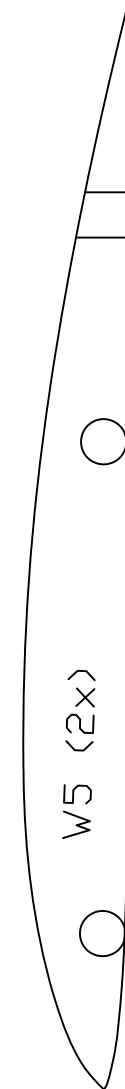
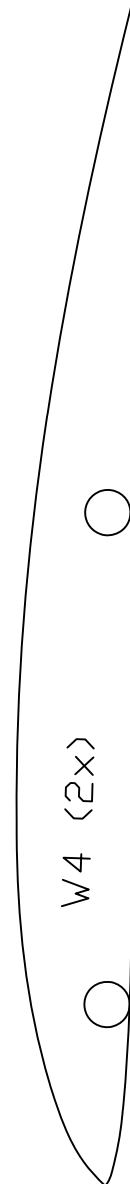
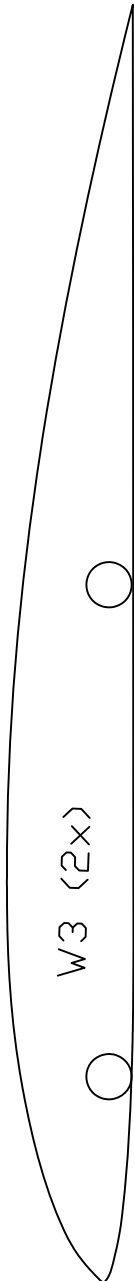
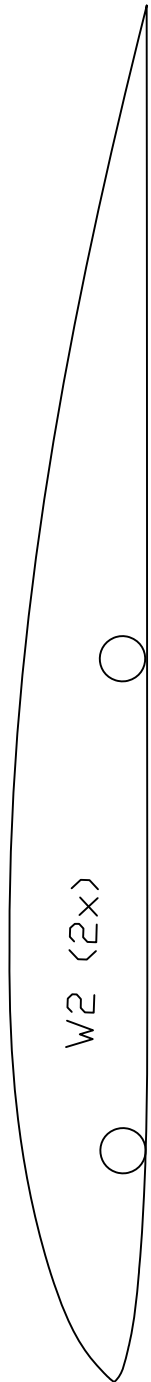
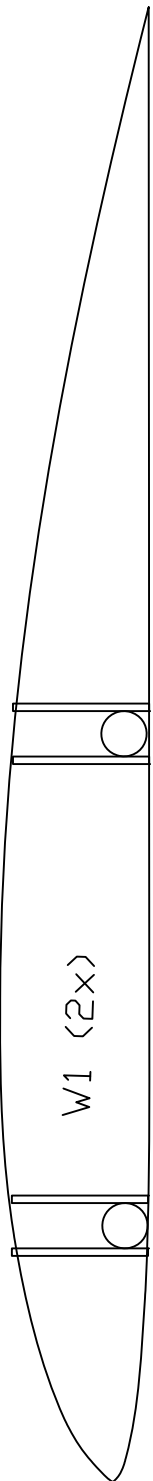

G1 (4x)
1mm Sperrholz

G2 (2x)
6mm Depron

T5

W7 (2x)

W8 (2x)

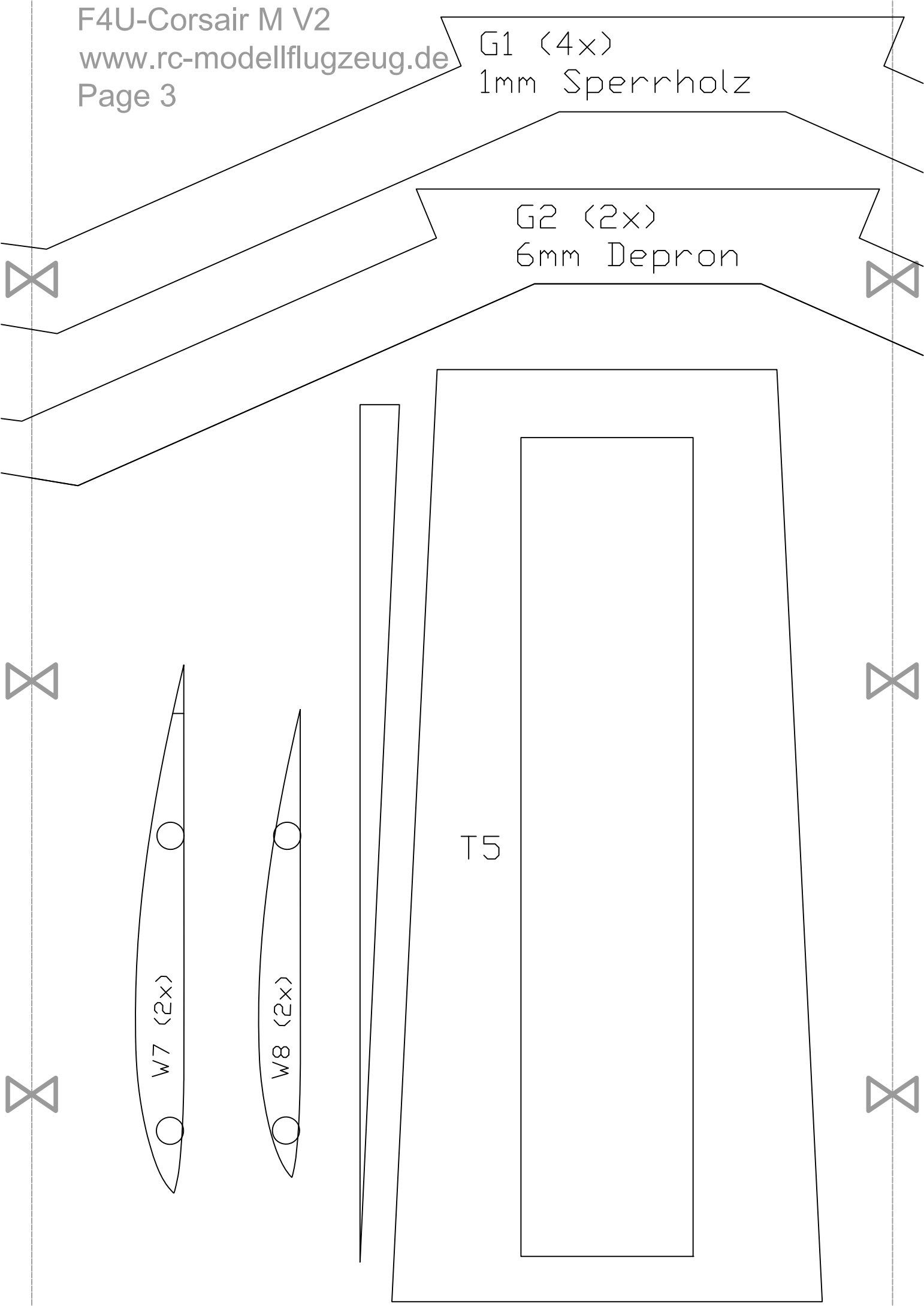

7

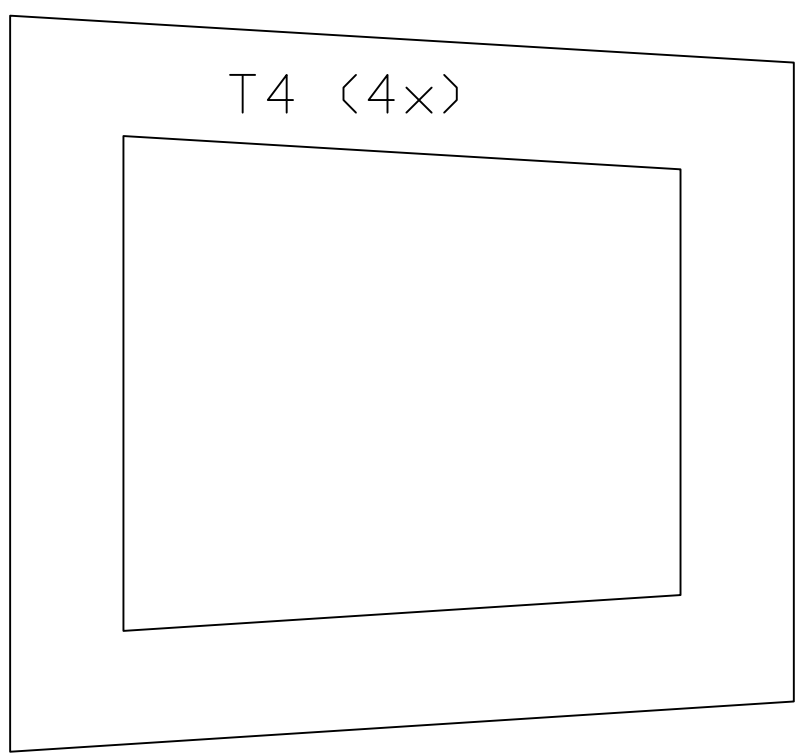
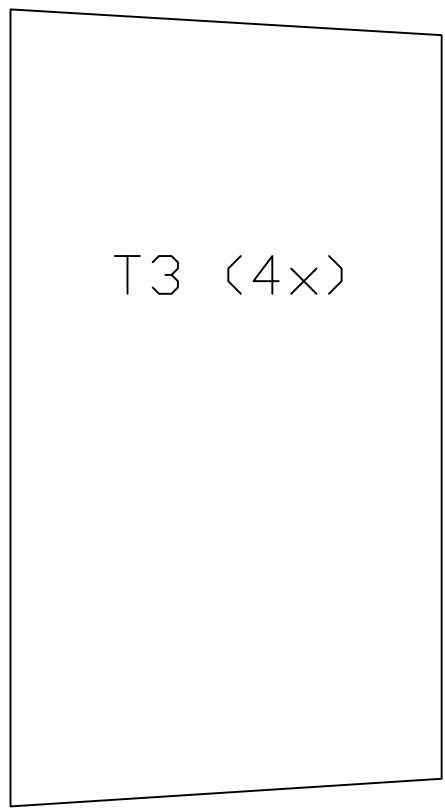
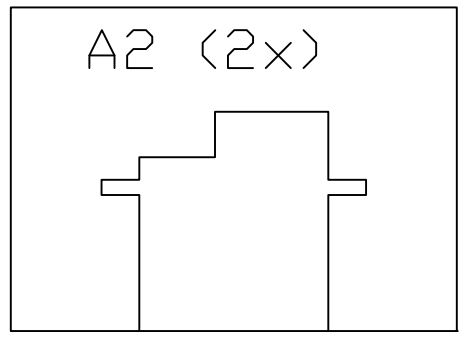
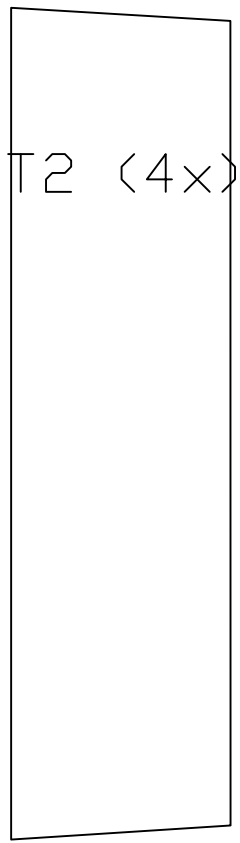
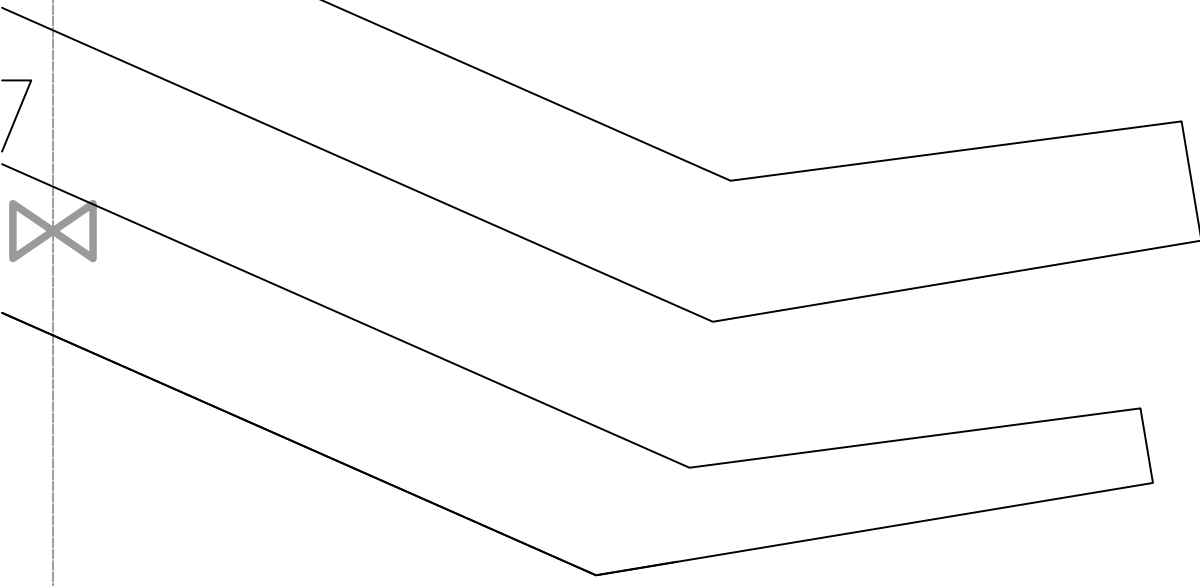

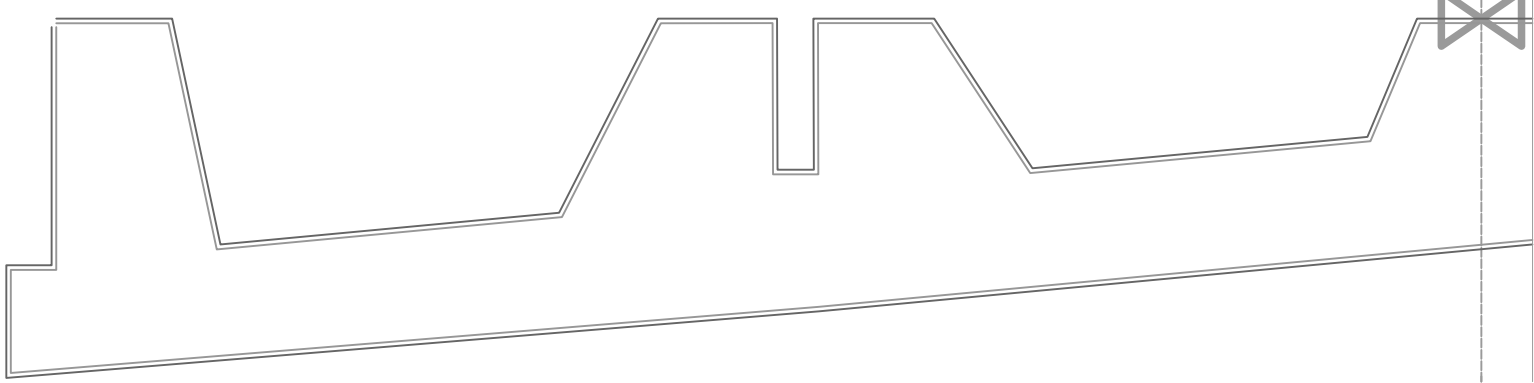
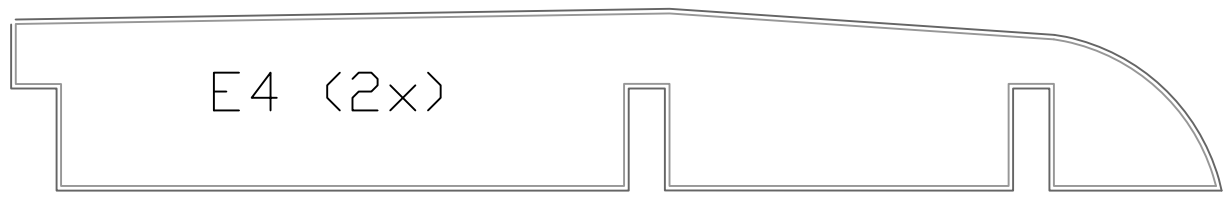
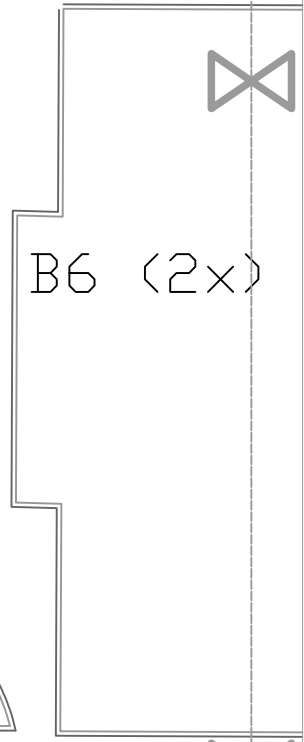
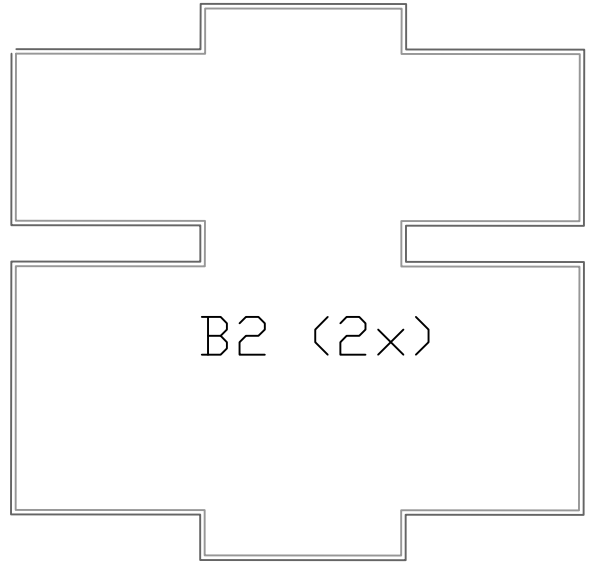
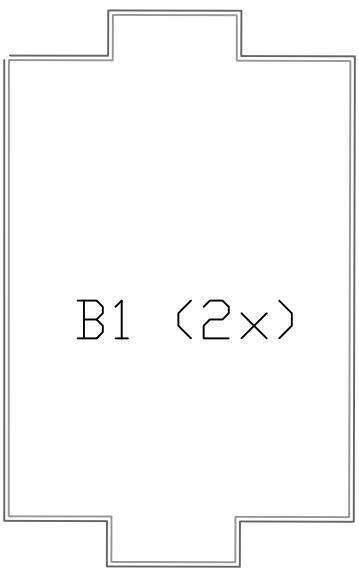
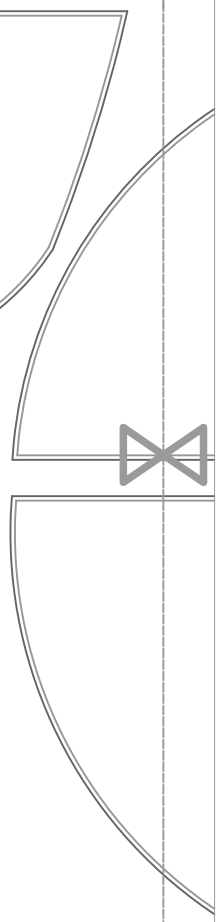
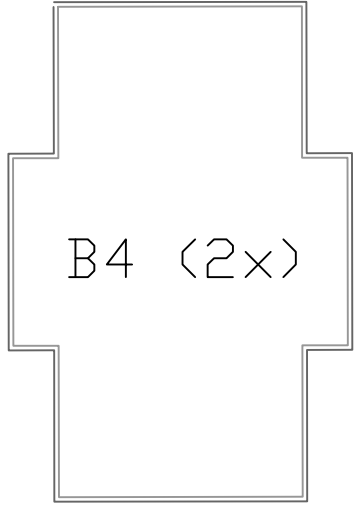
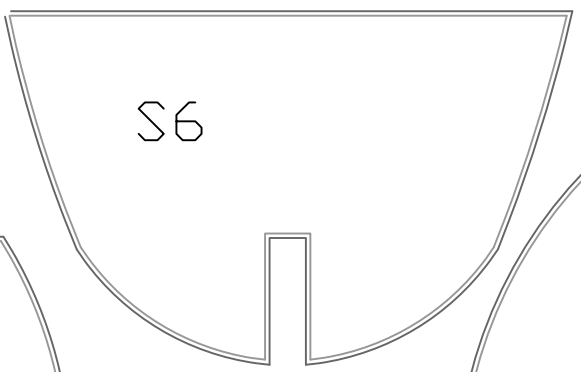
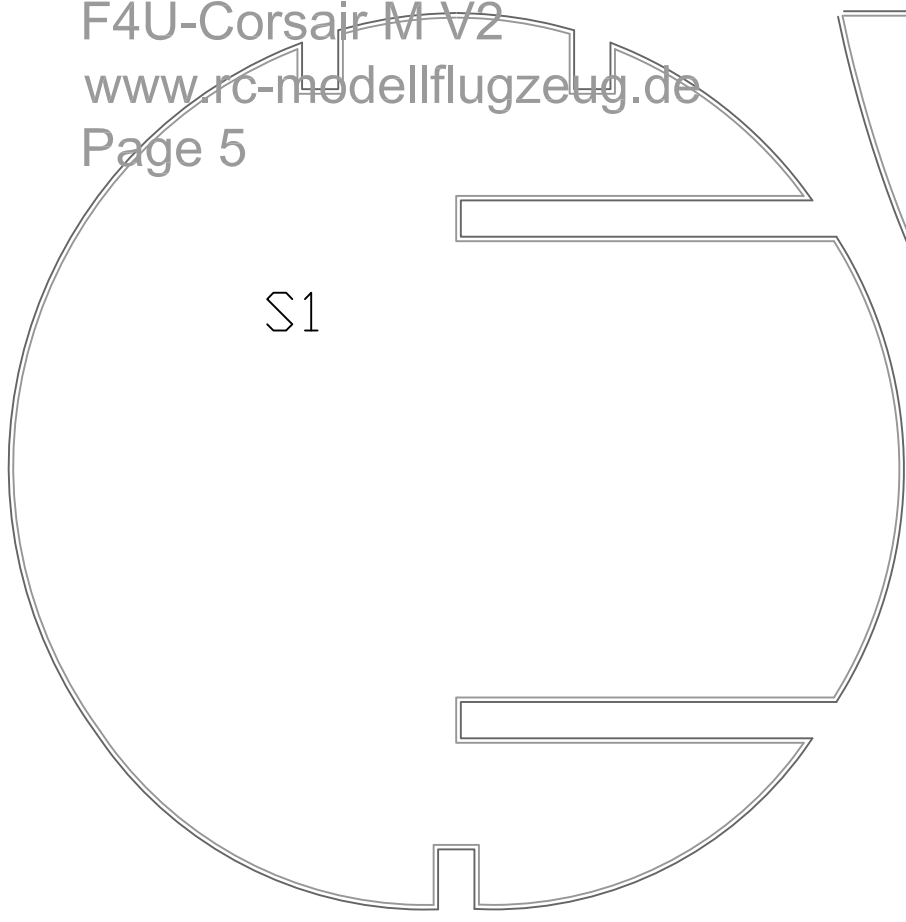

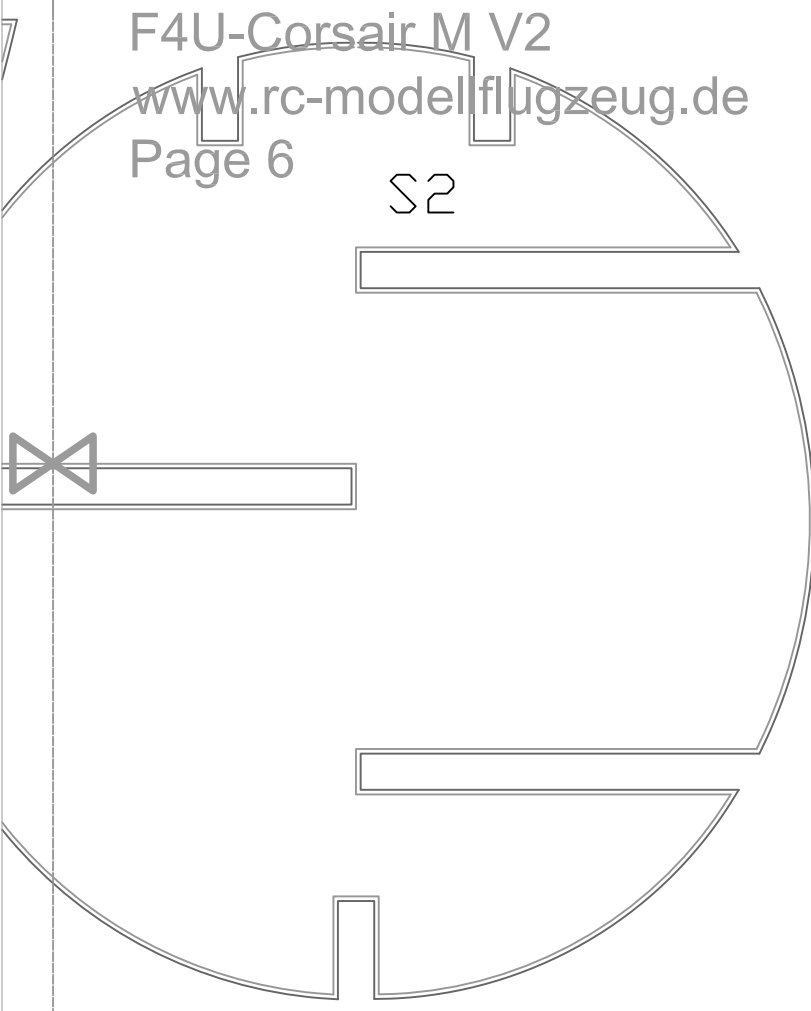

S2

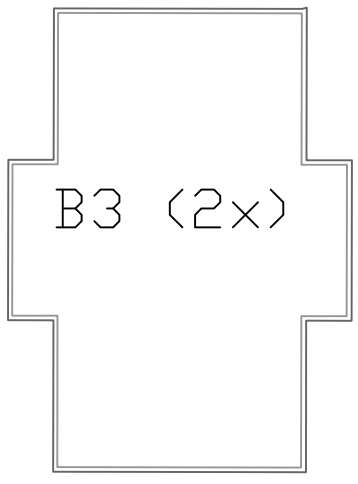

B3 (2x)

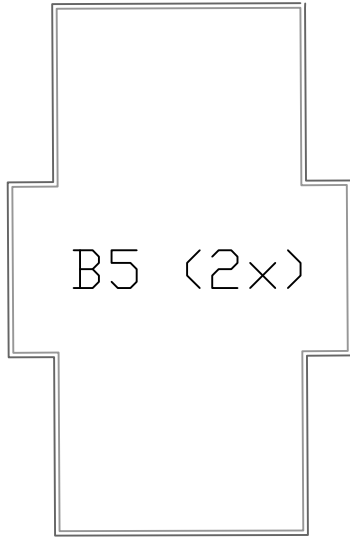

B5 (2x)

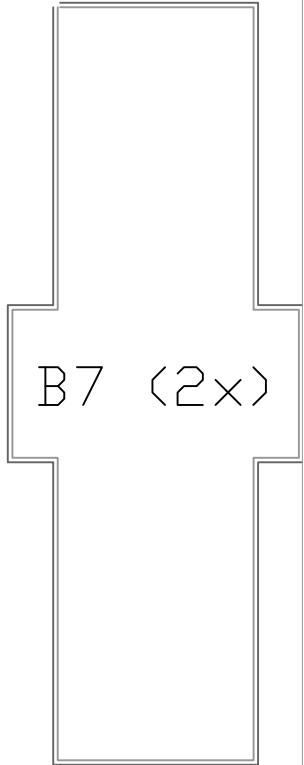

B7 (2x)

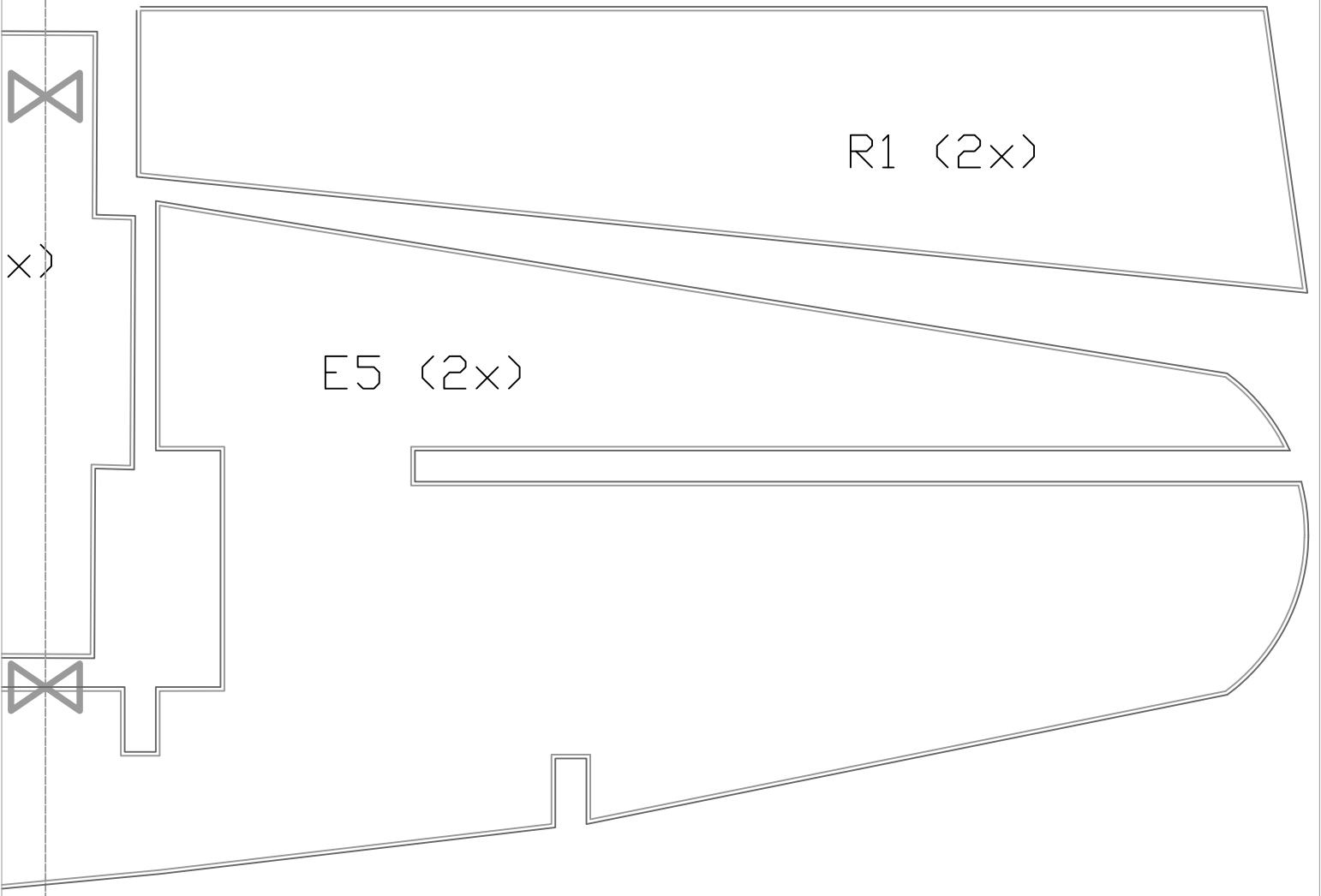

R1 (2x)

E5 (2x)

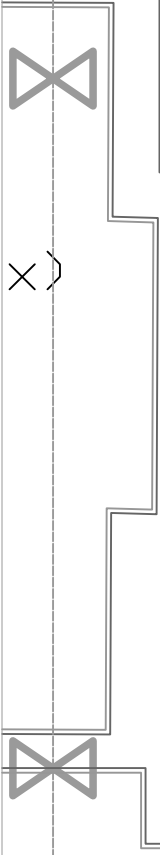

x)

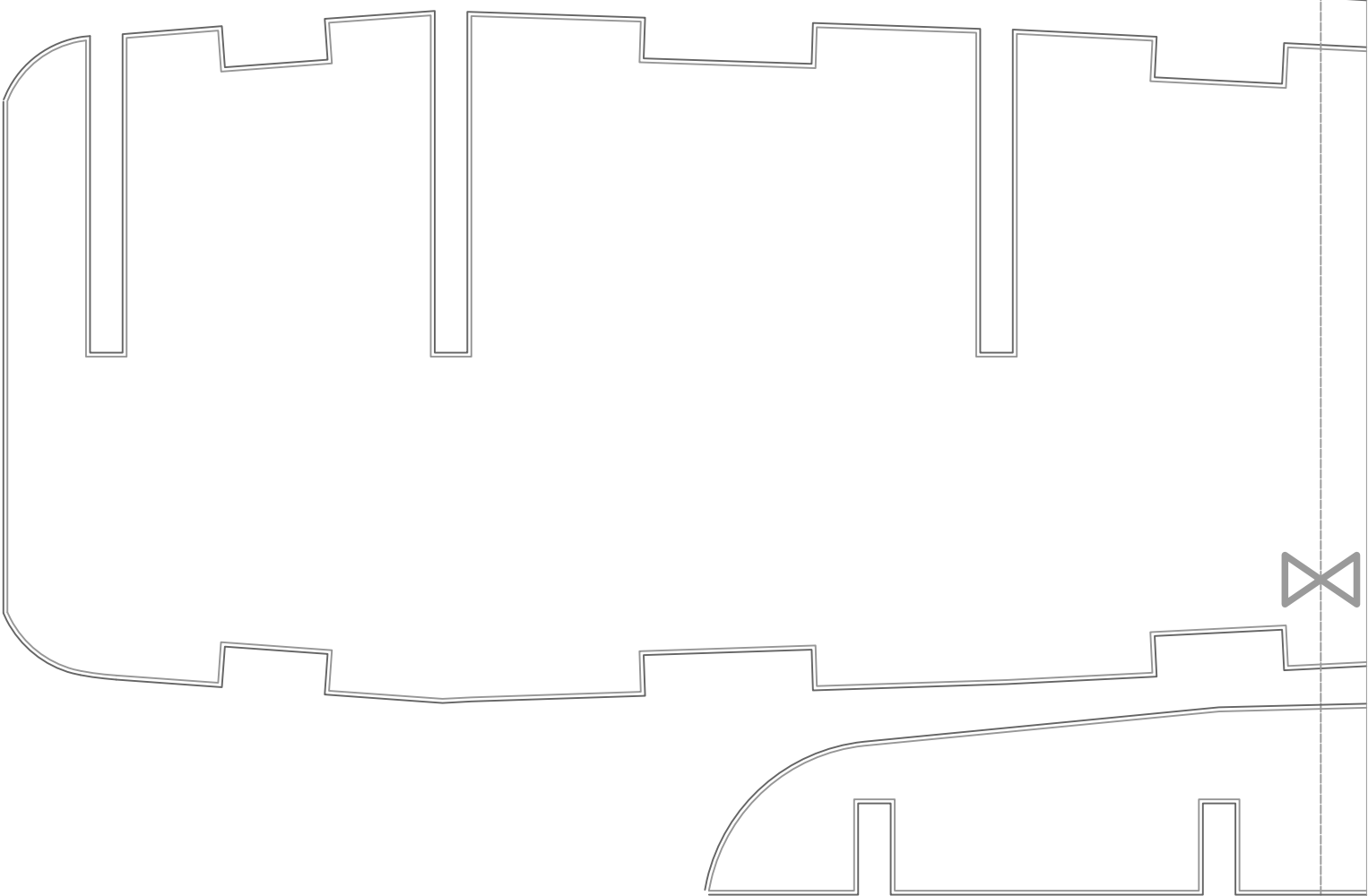
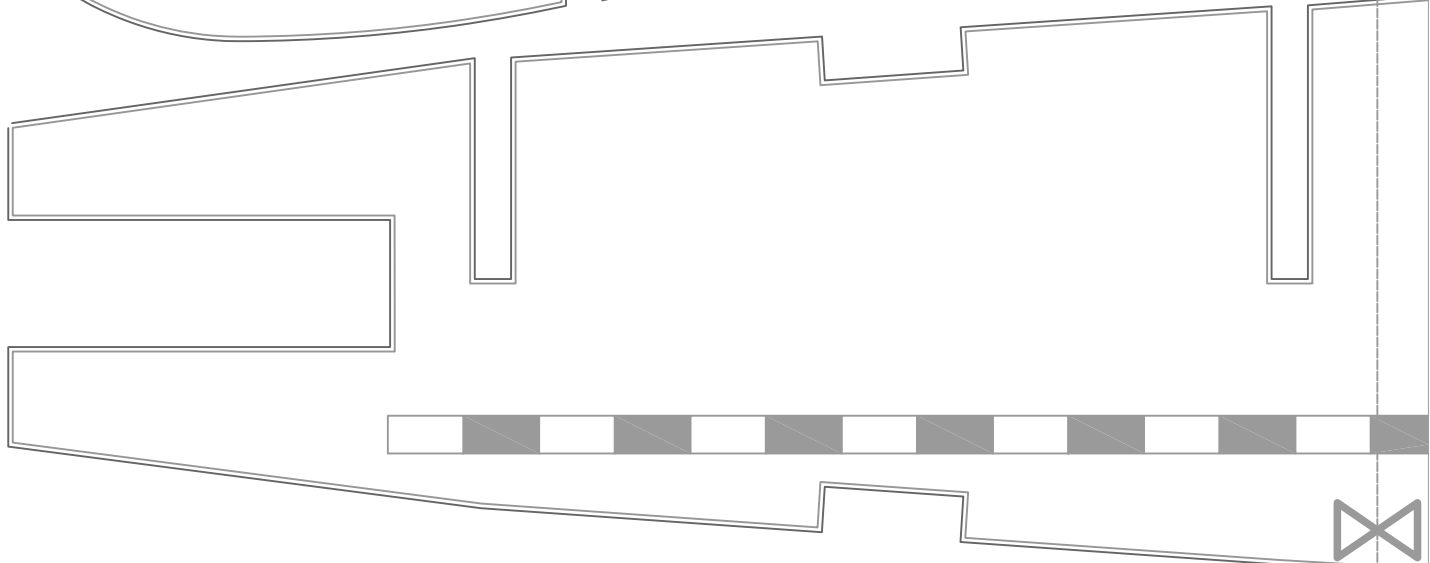
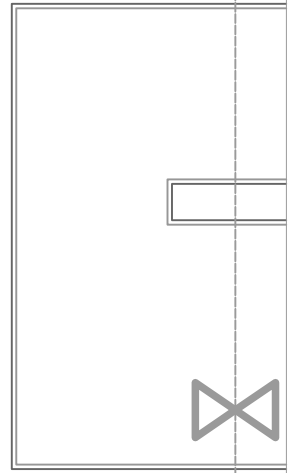
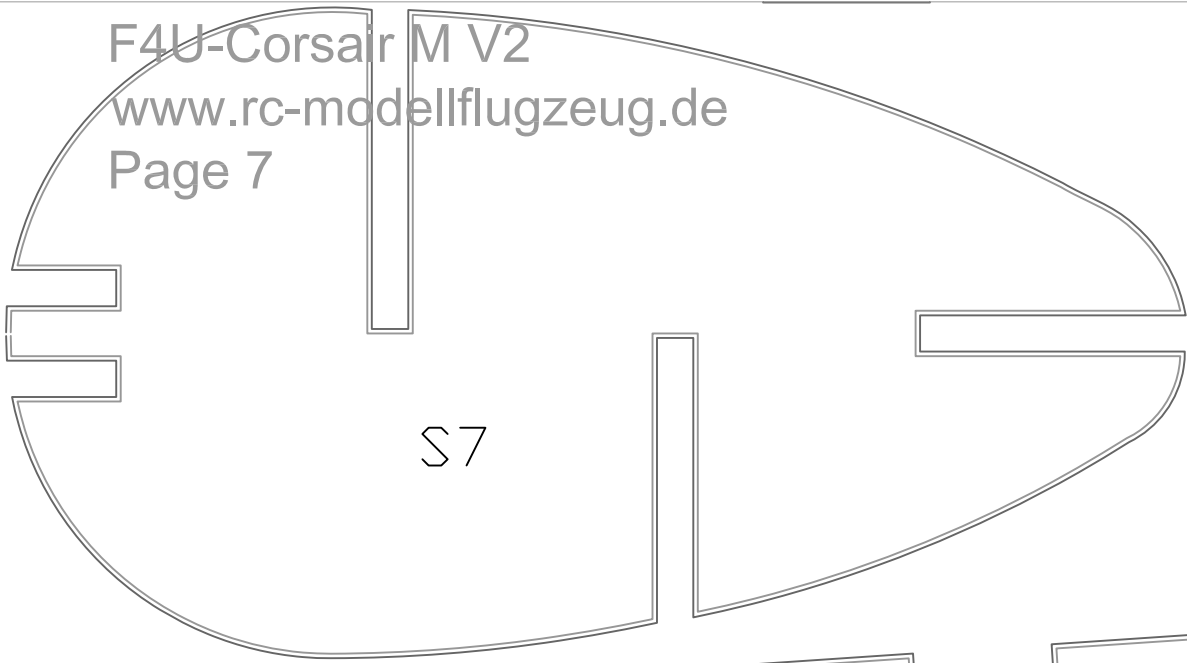

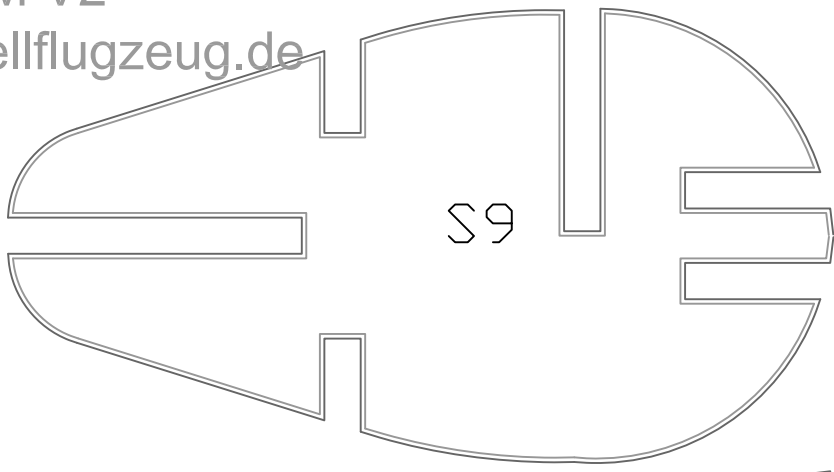

S9

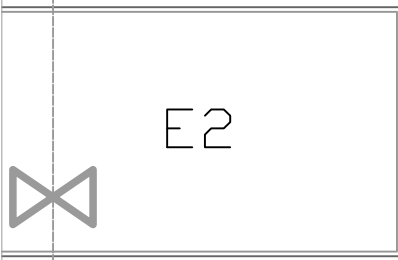

E2

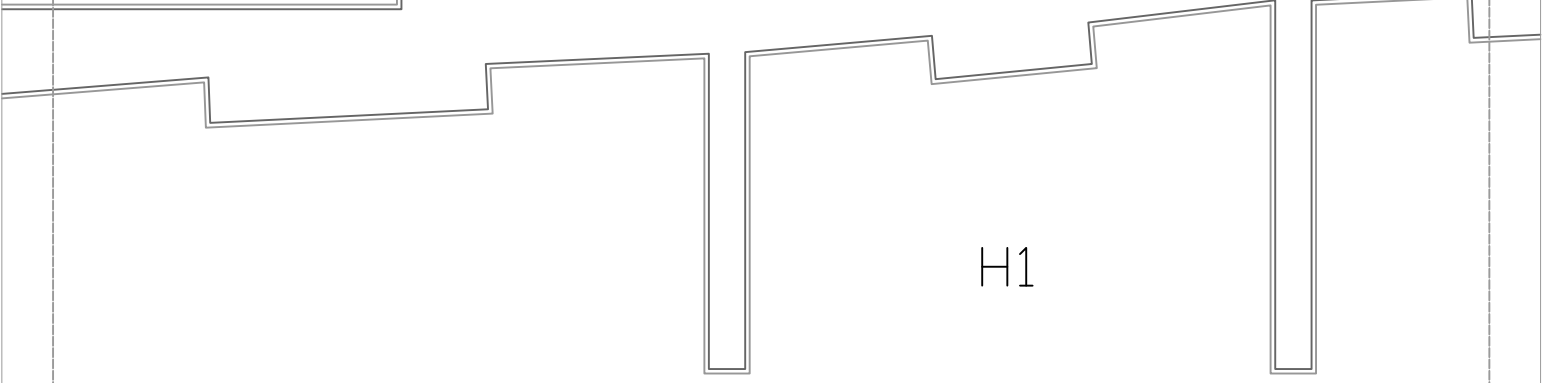

H1

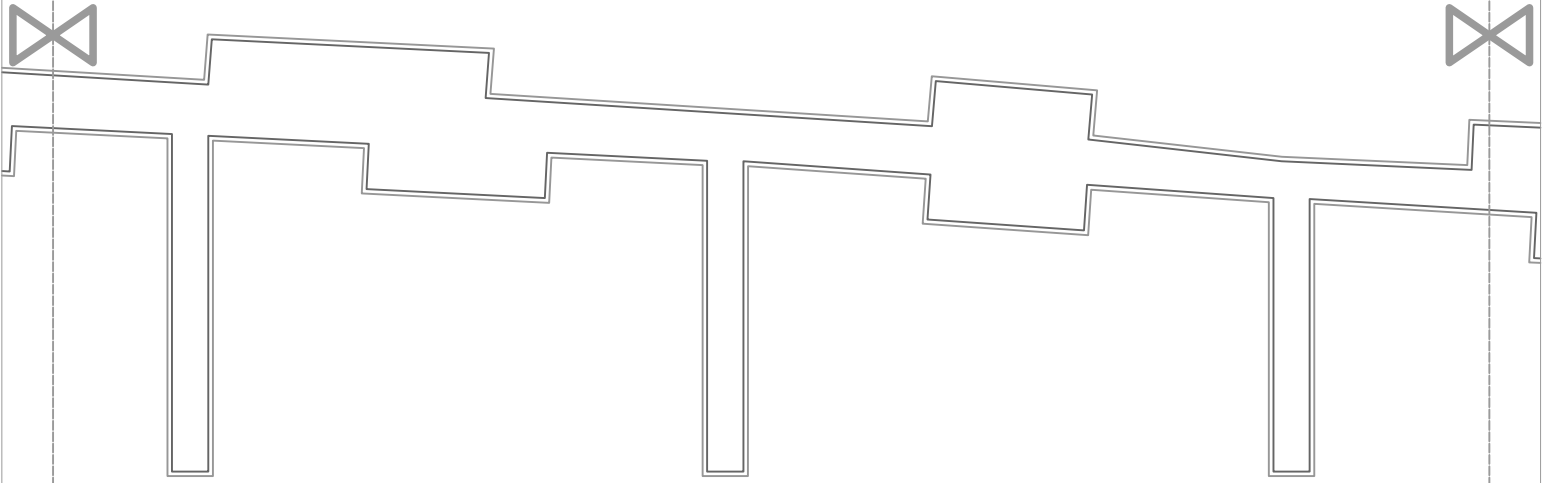

H2

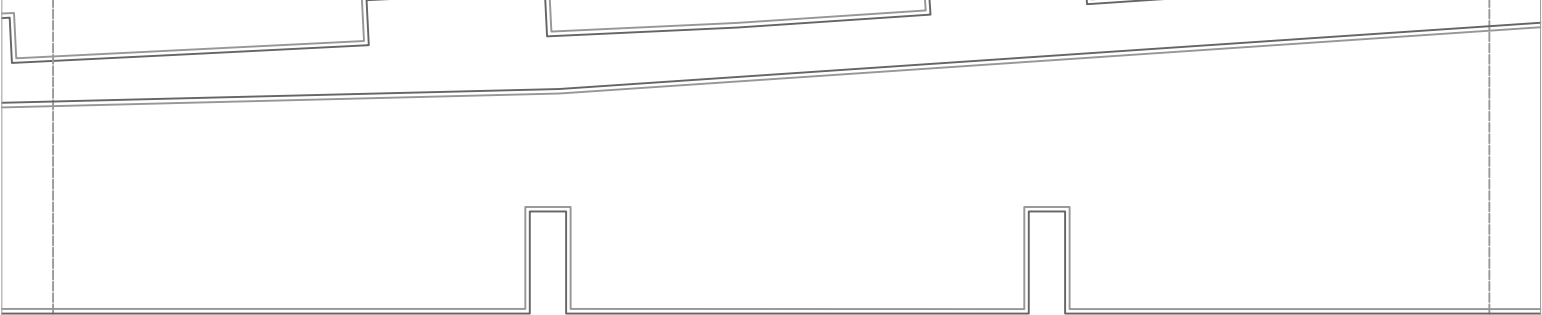

E3



E1

Servo

Servo

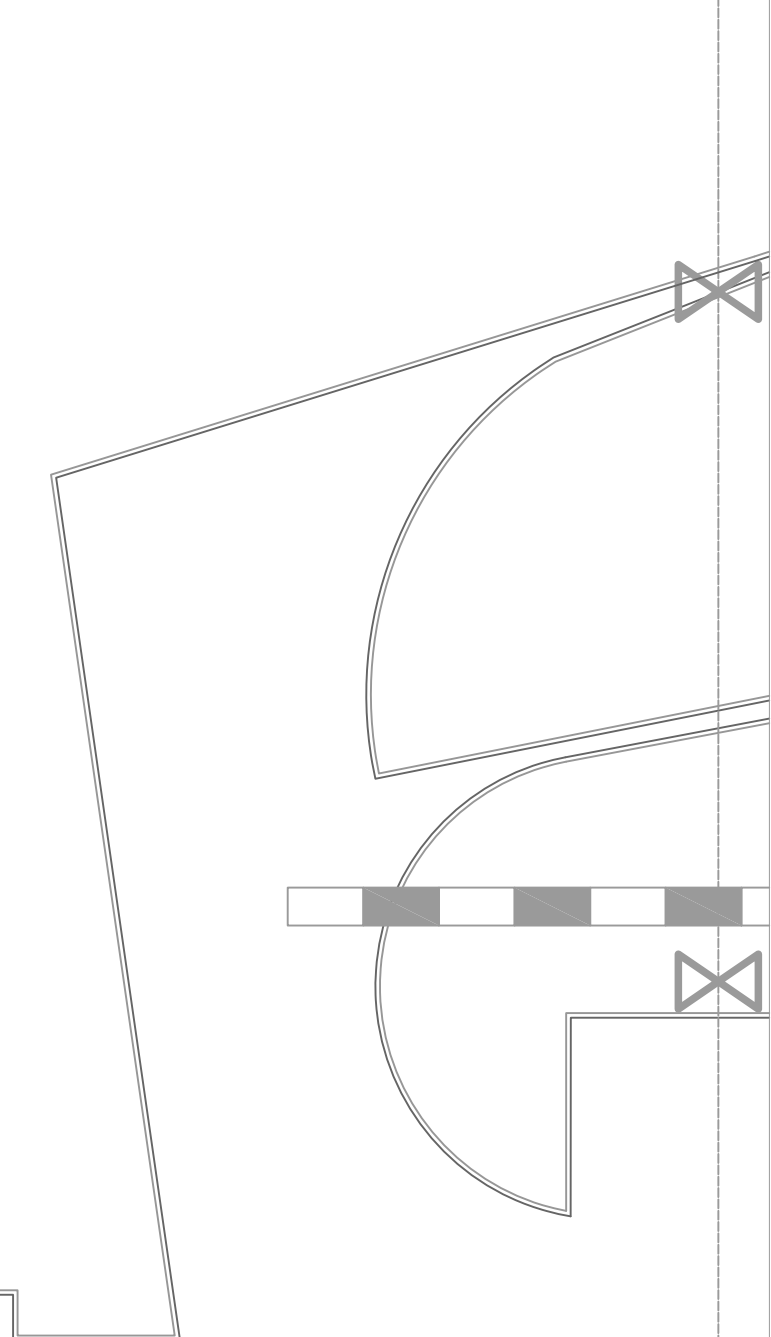
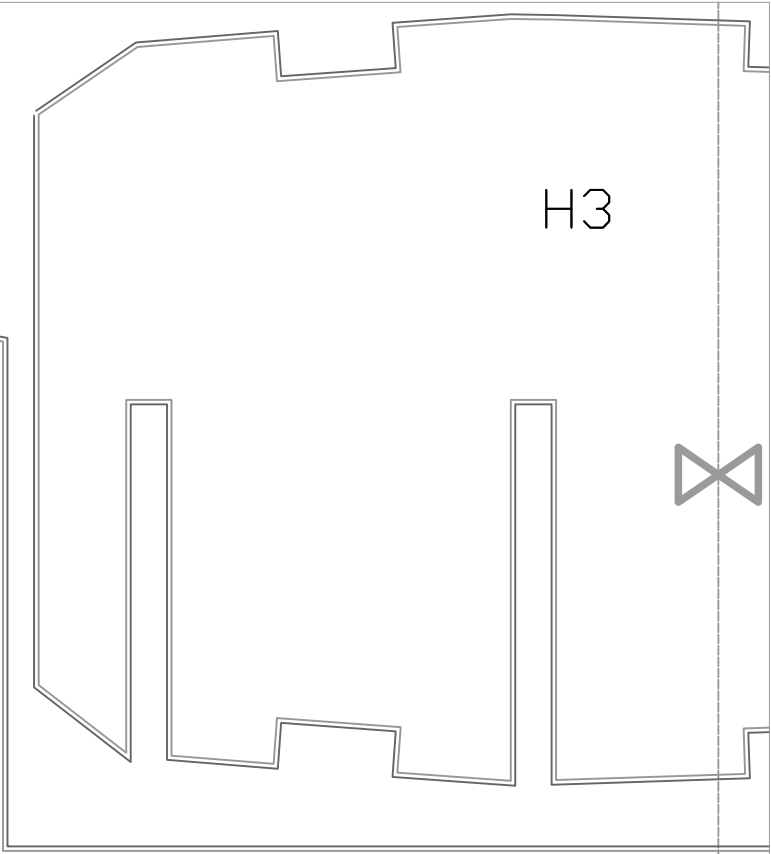
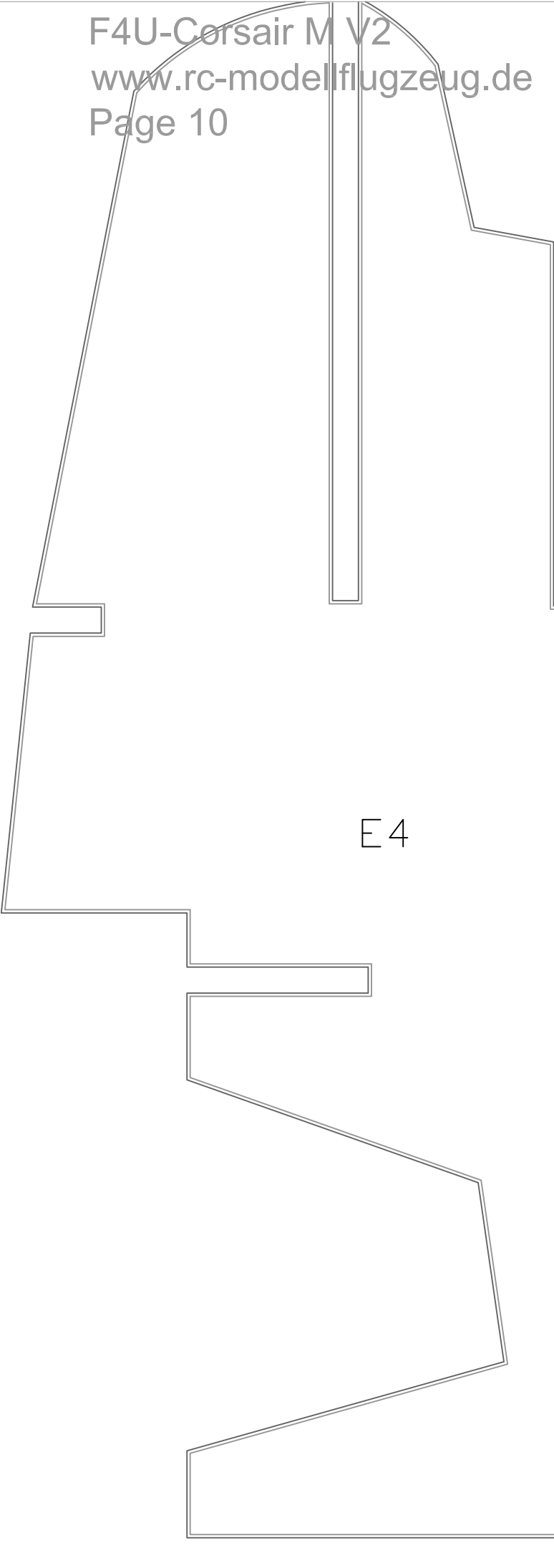

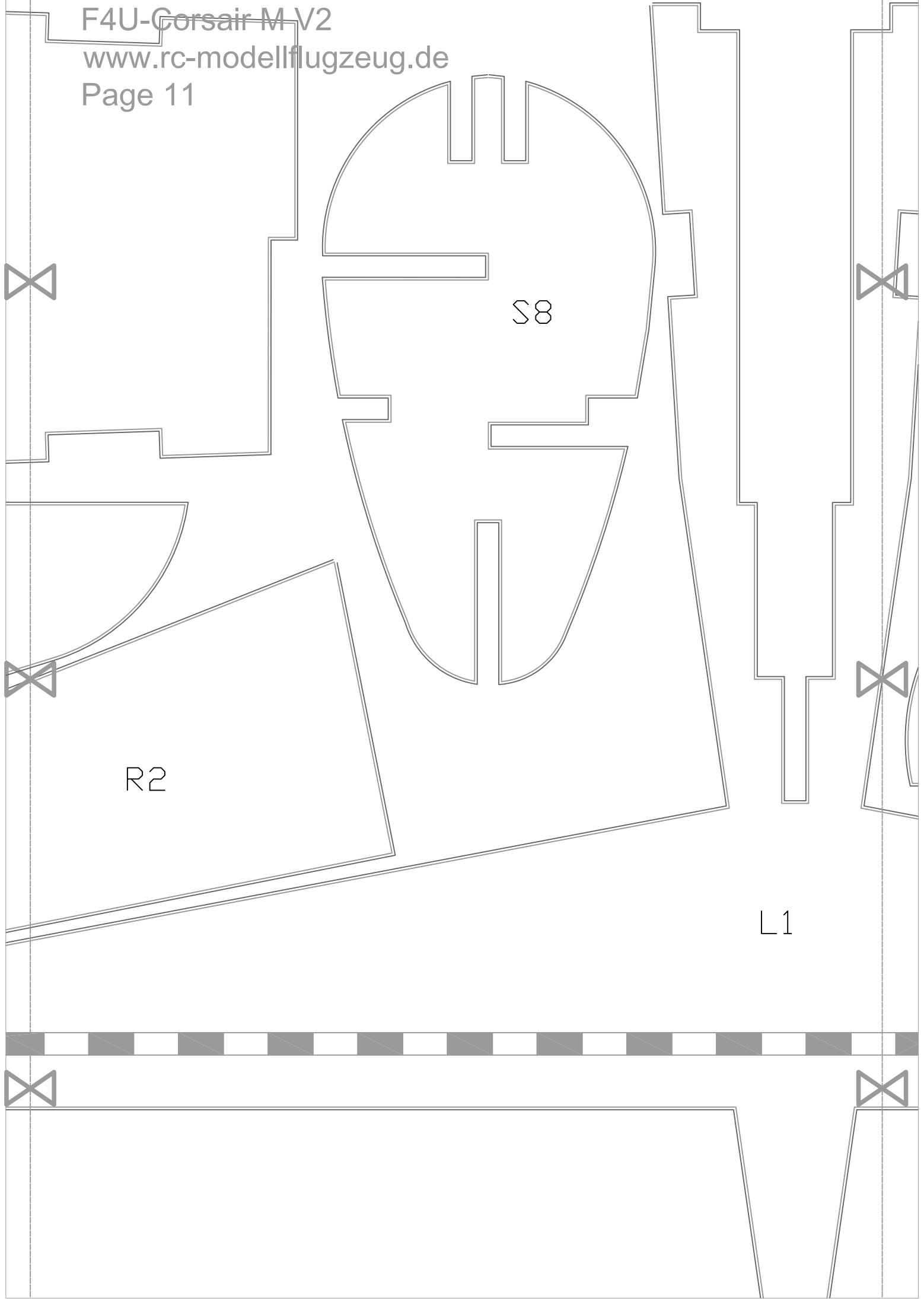

S8

R2

L1

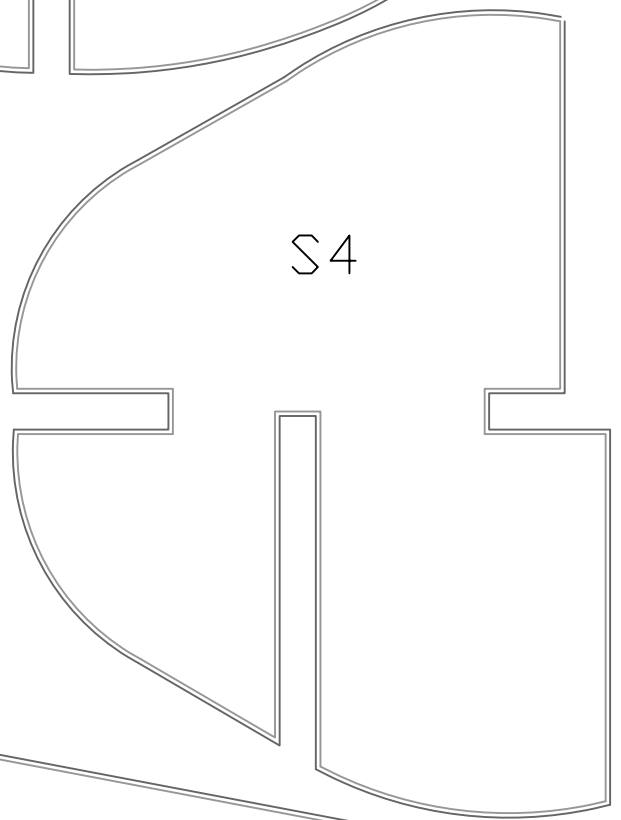
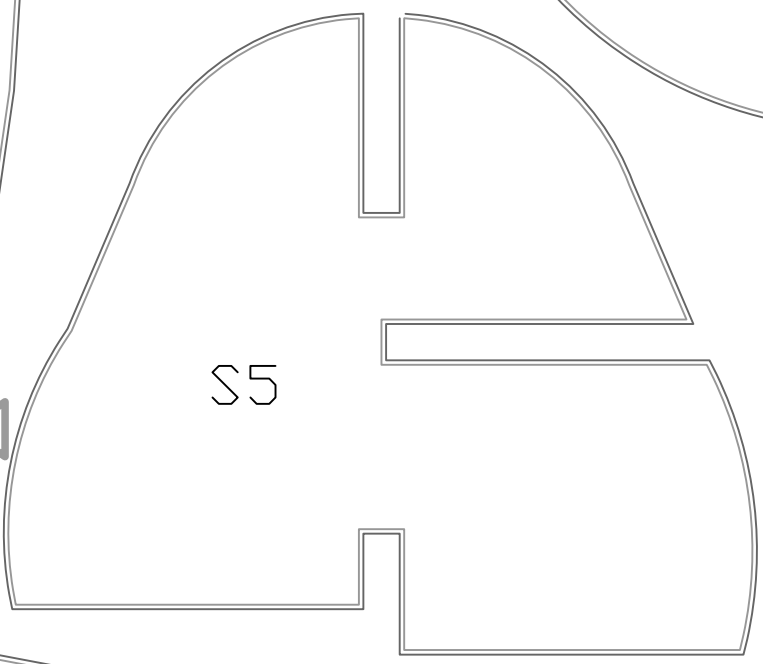
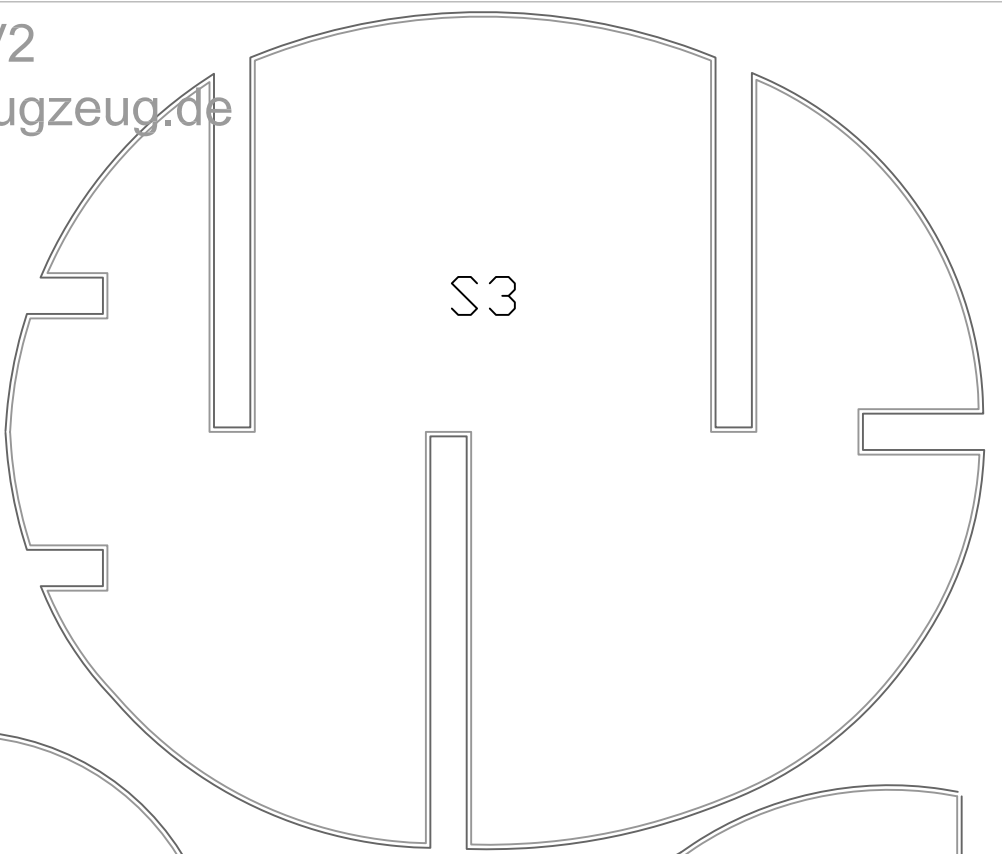
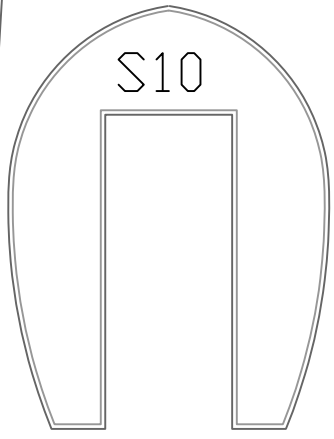

M3 (3mm Depron)



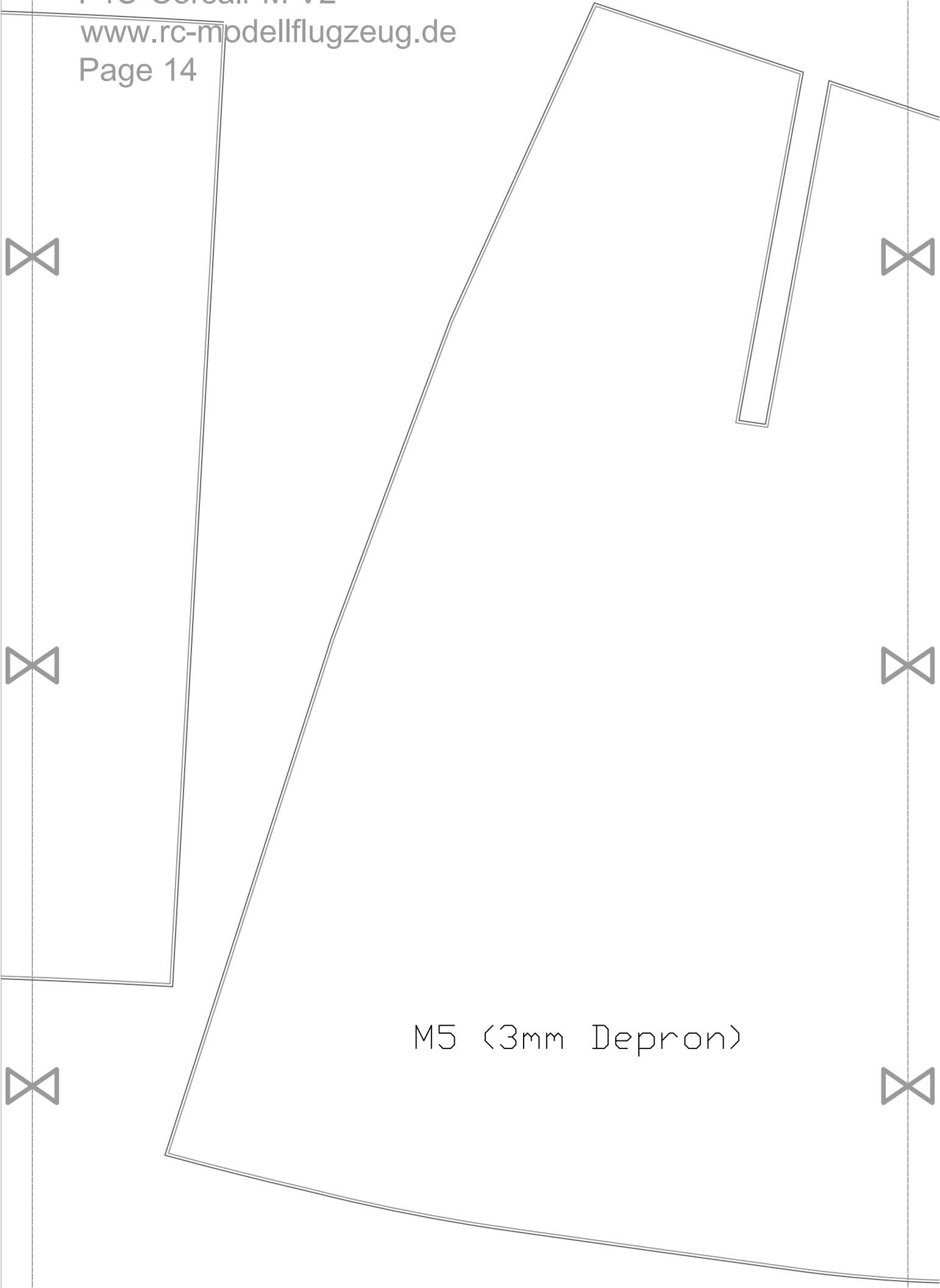

M5 (3mm Depron)



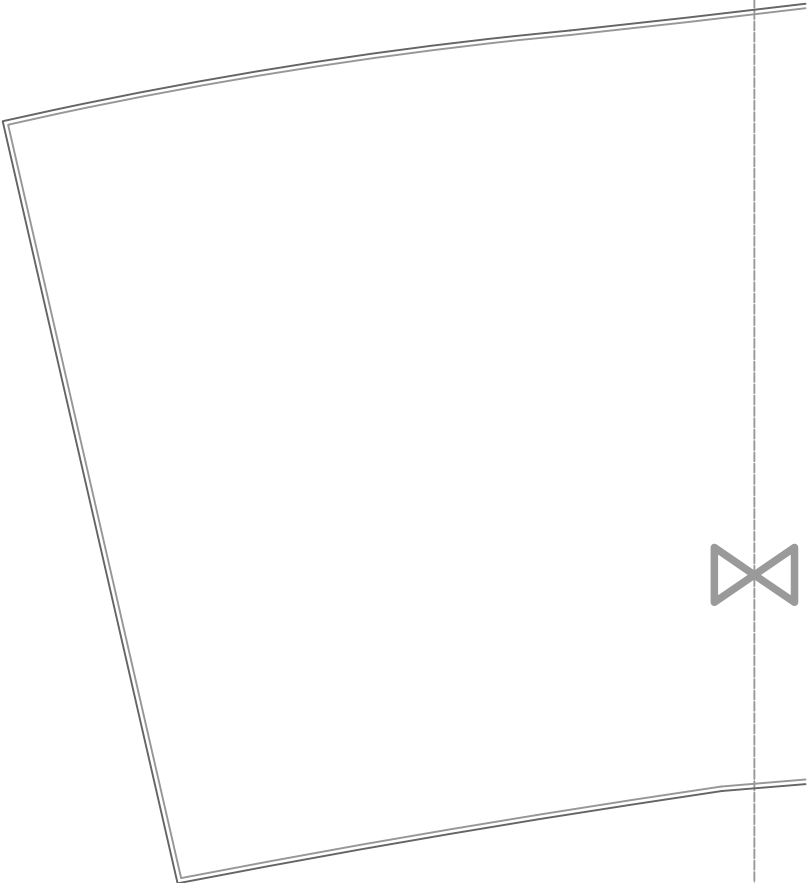
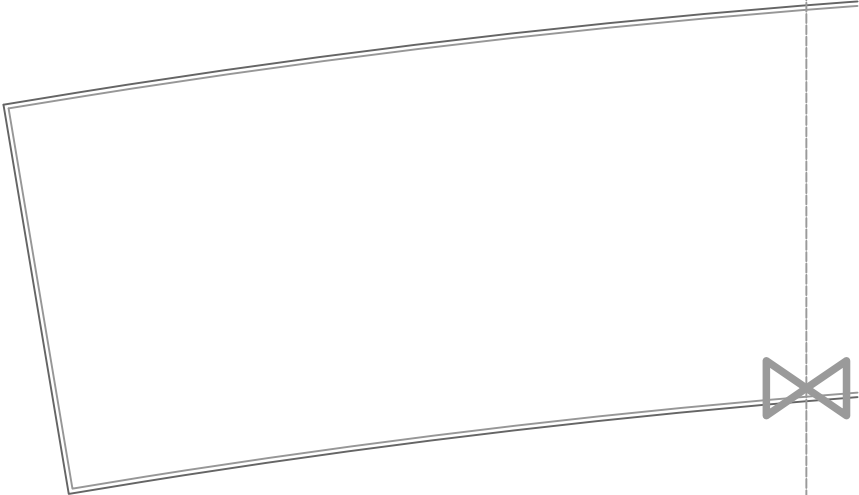



M2 (3mm Depron)



M1 (3mm Depron)



M4 (3mm Depron)



Add Page 22

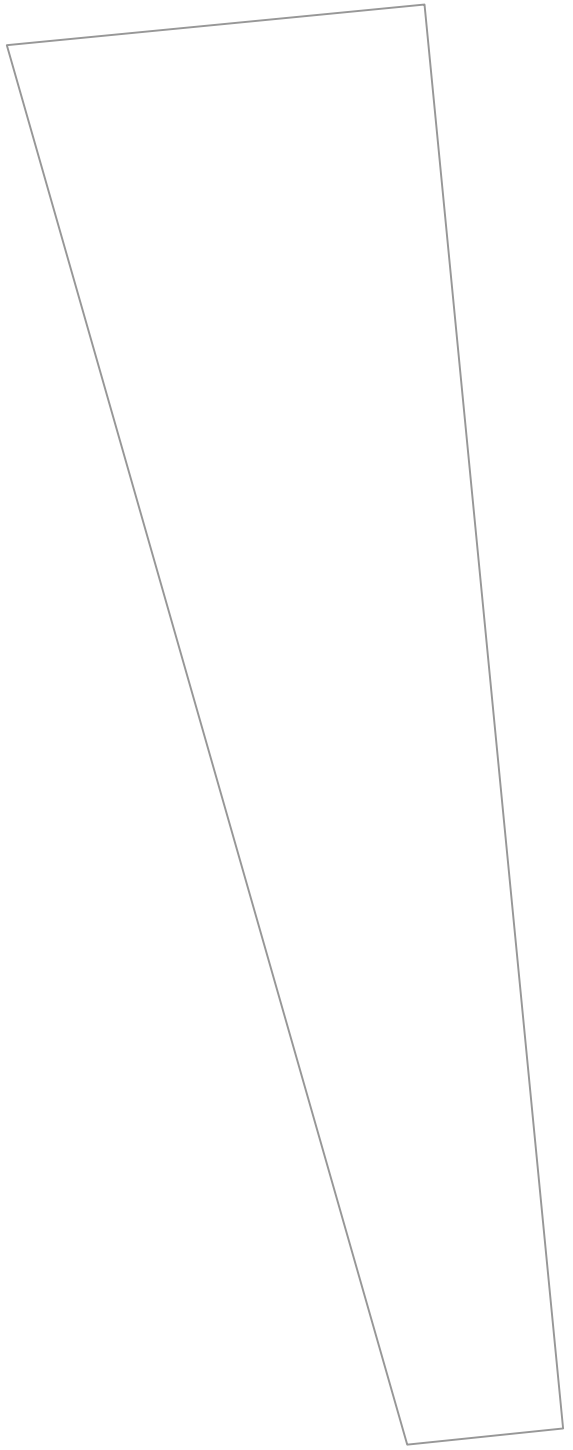

W4

W5

W6

W7



Add Page 20

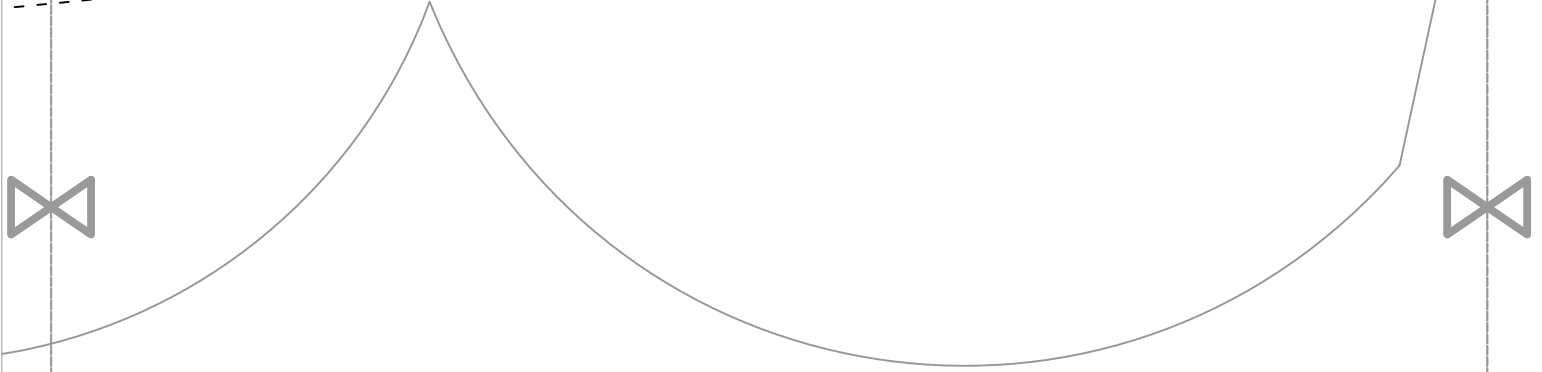
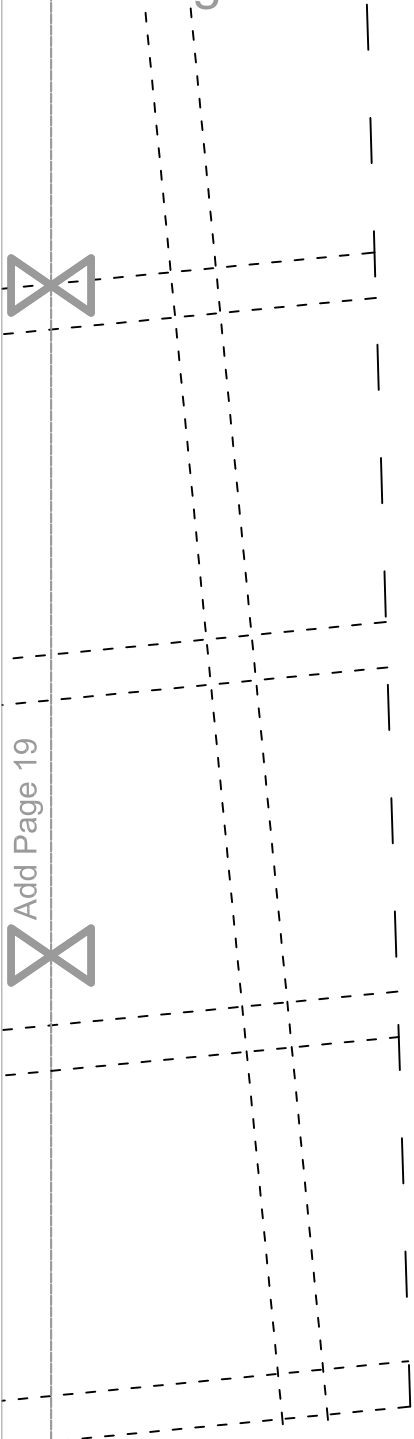

Add Page 19

Add Page 21

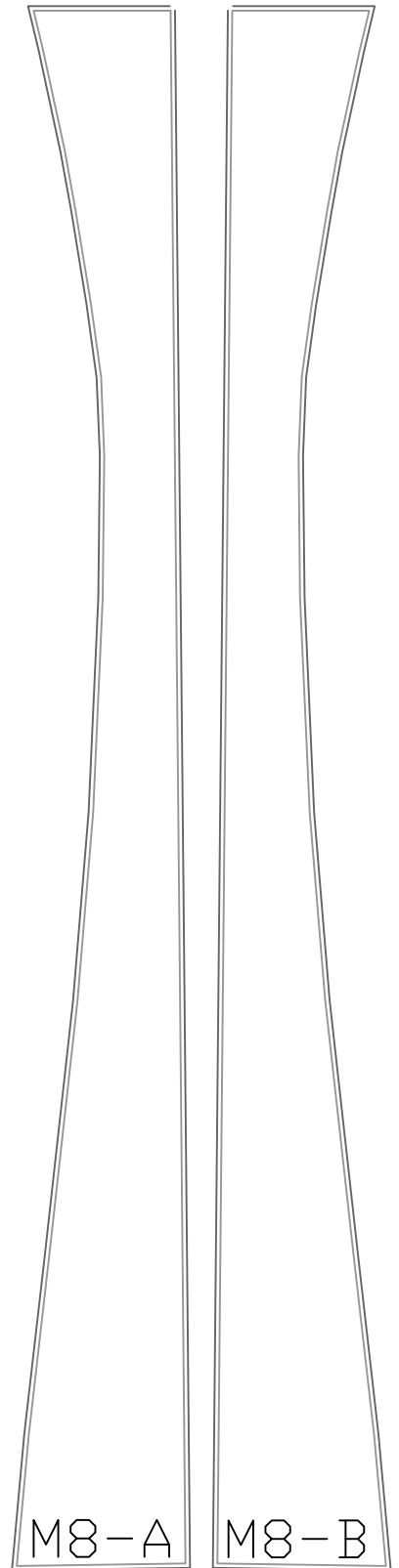
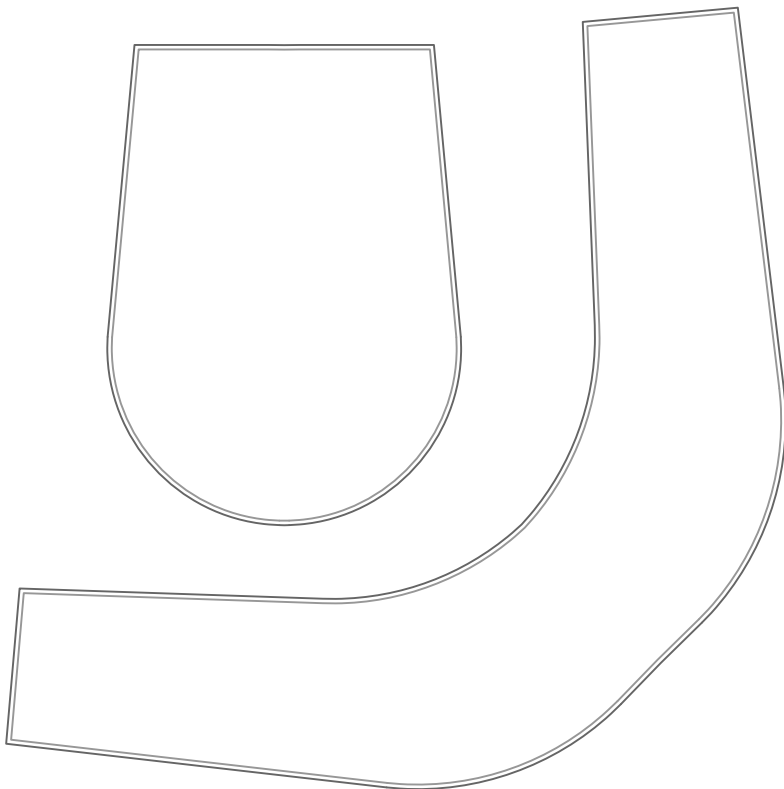

M8-A

M8-B

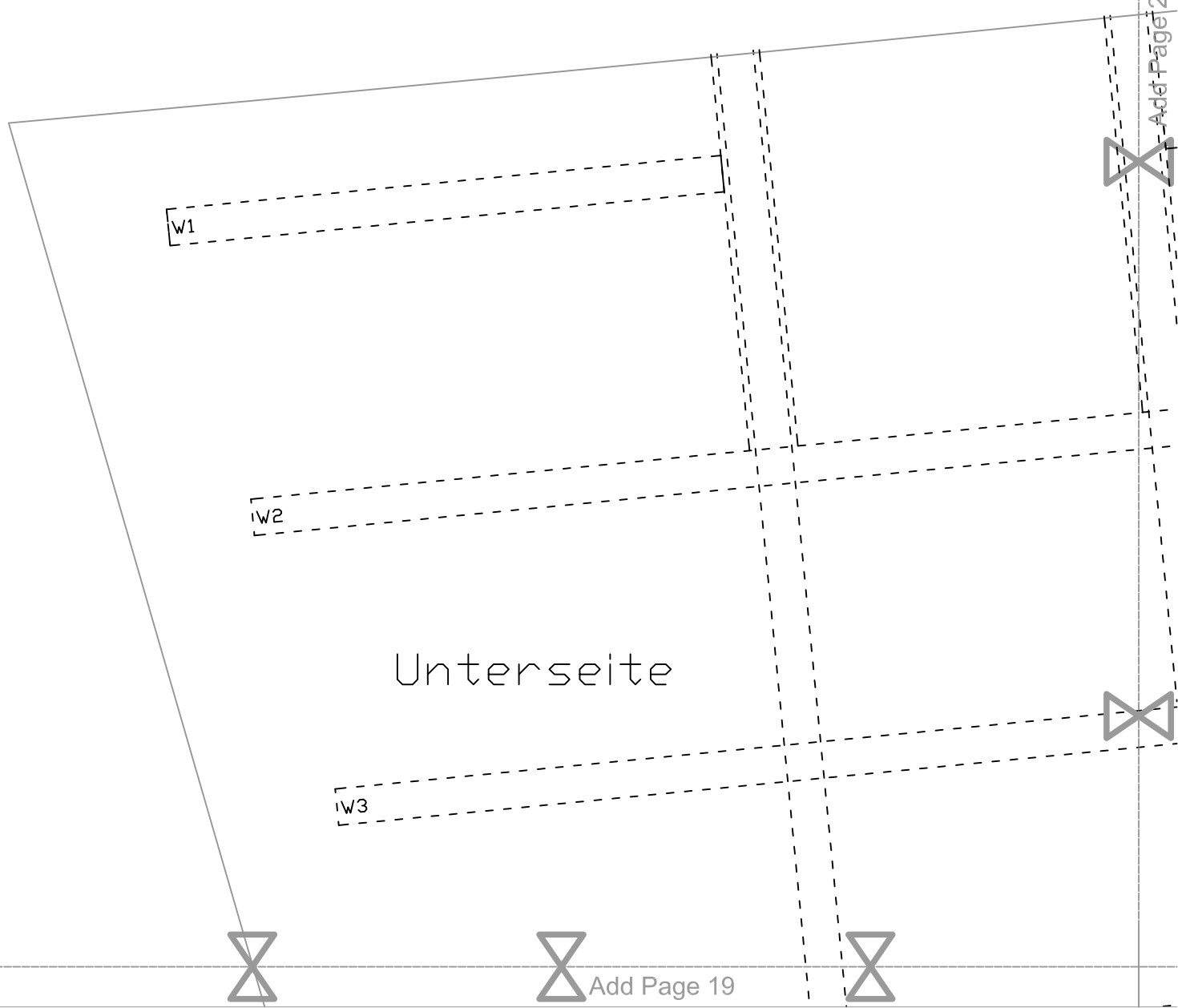
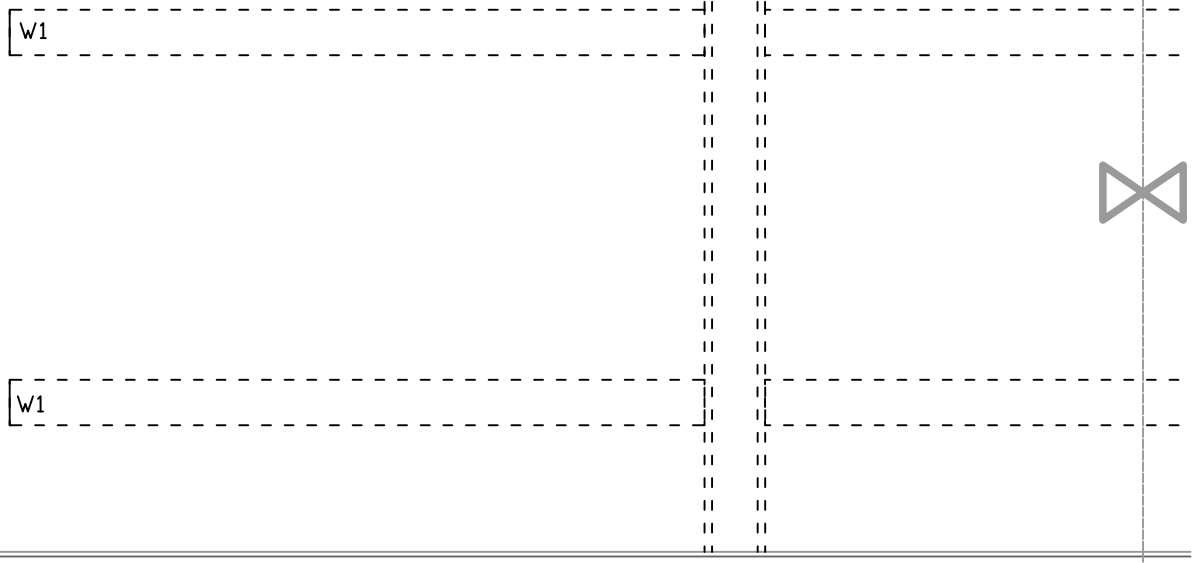

Add Page 23



Add Page 19

M9 (2x) (3mm Depron)

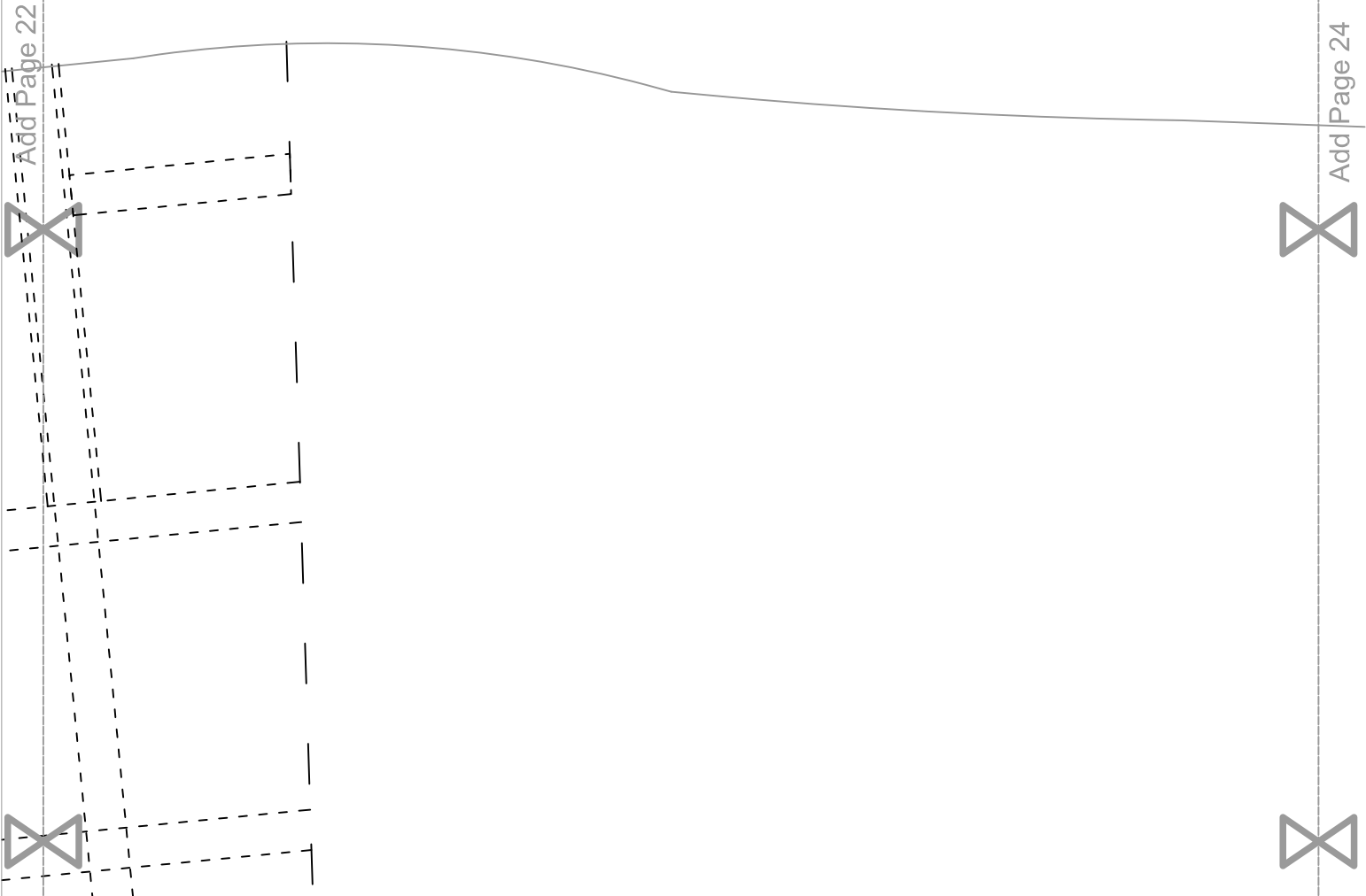
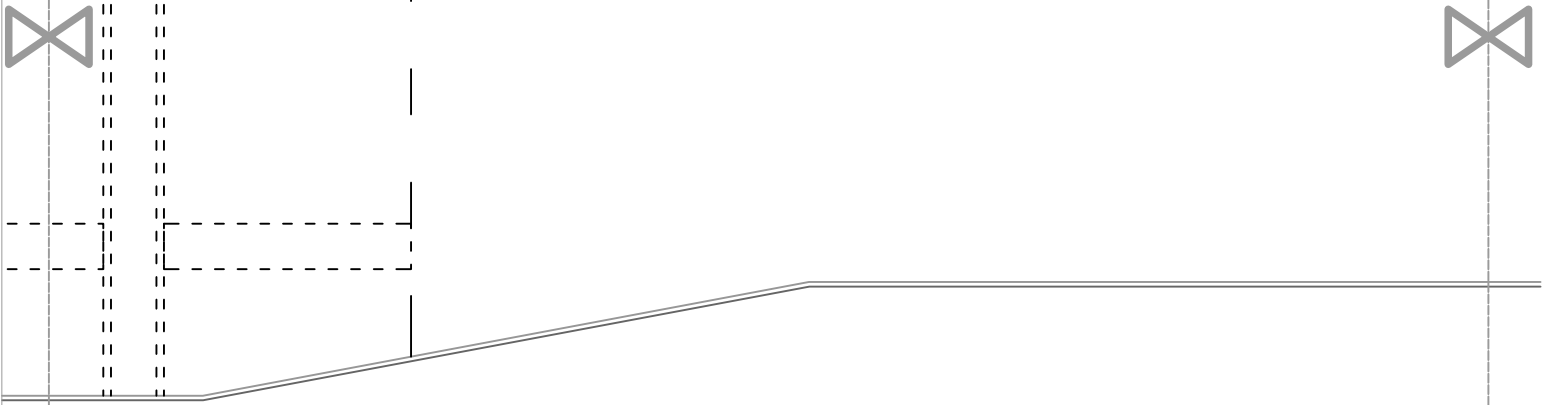

M6 (2x) (3mm Depron)



Add Page 22

Add Page 24



Add Page 23



M7 (3mm Depron)



Add Page 21



F

A

N

A

V

E

N

A

V

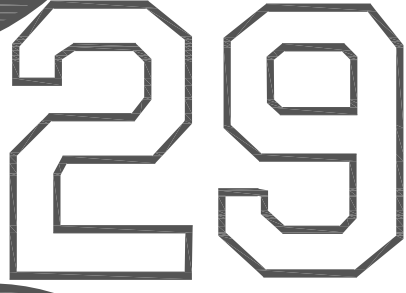
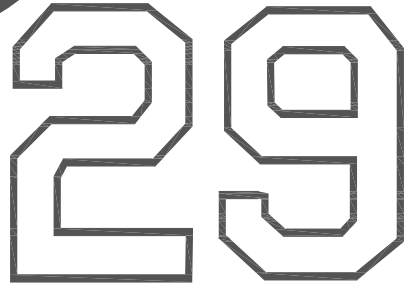

NAVY